



**Solis - Global  
Leading String Inverter**

Developing technology to  
power the world with clean energy

**COMPANY  
MISSION**



# WHY SOLIS

## Solis Financial Stability

We remain committed to our global expansion plans, building upon our strong presence in Europe as well as Asia and the Americas.

Ginlong Technologies were the first company with a primary focus on string inverters to be listed on the Shenzhen Stock exchange and we are proud to be endorsed by leading global banks and financial institutions including Bank of America, JP Morgan Chase & Co. and Mosaic to name a few.

Our proven bankability ensures solid long-term return on investment as we continue our journey towards a more sustainable and carbon zero world.

### \$ Global Sales

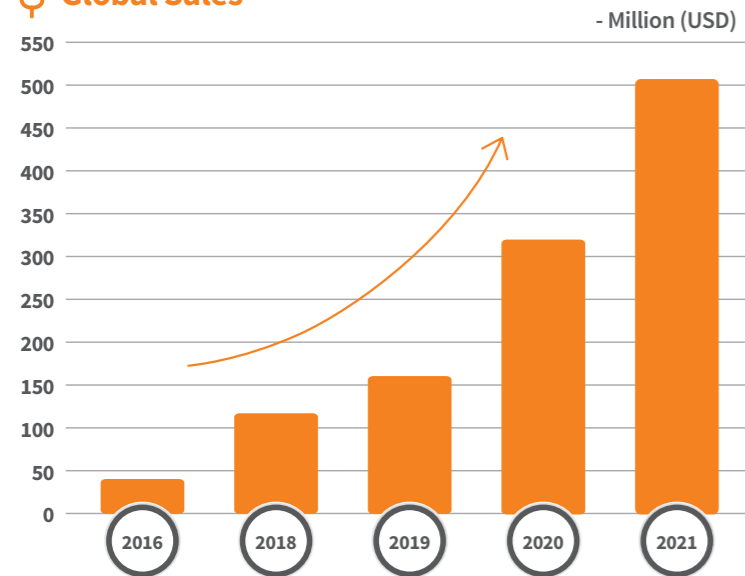

Total assets of **\$1355+ million USD** with no bank debt

### Understanding our Customers

Ginlong Technologies manufacture and develop products across all solar market sectors. Our strength in research and development, coupled with our world class supply chain and manufacturing capabilities mean we are able to tailor and optimise our products for regional markets. All customers are supported by our industry-leading teams of local technicians, who are available online, on the phone and in the field.

### Technical & Industry Expertise

Over 500 engineers and scientists are employed to innovate, develop and source components for Solis inverters. It is their keen eye for detail and stringent quality control processes which have contributed to the achievement of multiple product awards and our reputation for reliability. We strive for excellence in innovation, developing unique, cost effective customer driven solutions, all of which are produced in our state-of-the-art manufacturing facility.

## Solis Research, Development & Innovation

We put a high investment in R&D to keep up with the demands and pace of change in the renewable energy sector. Solis has been actively involved with Chinese national bodies in the formulation of 10+ national and industrial standards and has developed two national standards. As a key participant in laying down industrial standards for solar string inverters, Solis takes its responsibility very seriously. Our vast R&D team has helped obtain approvals on multiple domestic and foreign authorised patents, and we remain one of the pioneers at the cutting edge of change in the industry.

### R&D expenditure has increased year by year

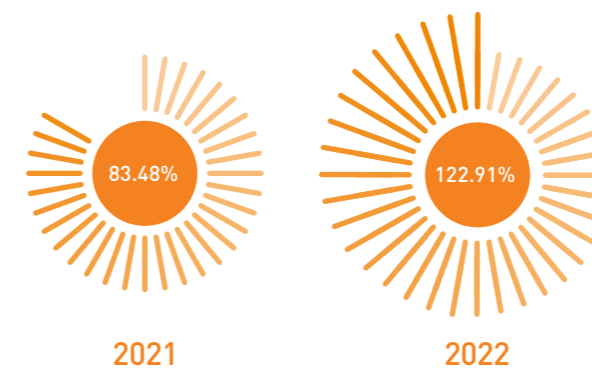

The inverter life models presented are positively impacted by the long and impressive track record of PV inverters designed and manufactured by Ginlong. The useful life projections are at or near the top of the string inverter life projections.

— DNV•GL

The company receives Top Brand award for 8 consecutive years.

— EUPD

IHS Markit (now part of S&P Global) estimates that Ginlong(Solis) was ranked the NO.3 PV inverter supplier globally in shipment terms in 2021.

— IHS

 National Enterprise Technology Center\*  
\* China's national level of recognition

 First inverter manufacturer to pass PVEL inverter reliability testing

 Endorsed by BloombergNEF as a bankable inverter brand

 National Industry / University / Research Cooperation

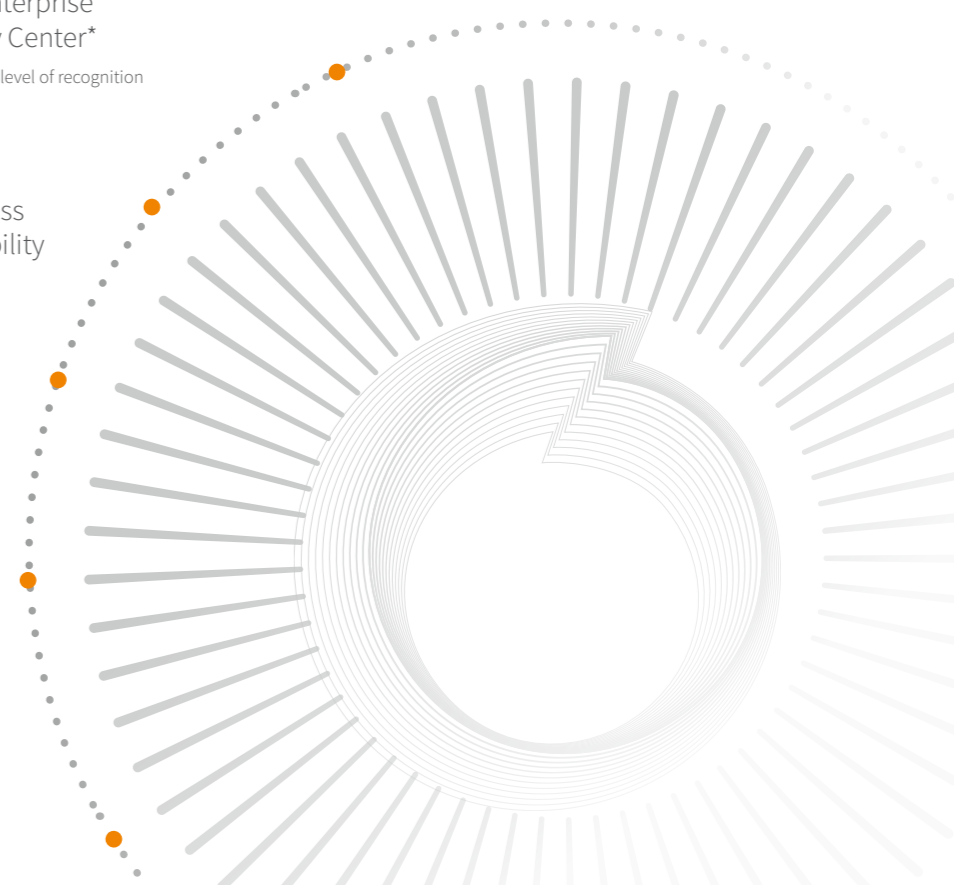

# COMPANY PROFILE

Established in 2005, Ginlong (Solis) (Stock Code: 300763.SZ) is one of most experienced and largest manufacturers of solar inverters.

Cost-effective solutions for residential, commercial, and utility-scale users deliver value at every level of the solar supply chain, engaging both homeowners and businesses, as well as power producers and renewable energy investors across the globe.

Presented under the Solis brand, the company's solar inverter product line uses innovative string technology to deliver first-class reliability, validated under the most stringent international certifications.

Combining a global supply chain with world-class R&D and manufacturing capabilities, Ginlong optimizes its Solis inverters for each regional market, servicing and supporting its customers with its teams of local experts.

Proven bankability has attracted support from world leading financial institutions, ensuring solid long-term returns on investment. Working with stakeholders to accelerate the worlds journey towards a more sustainable future.



**17**

17th Anniversary

**No. 3**

PV Inverter Shipments

**40GW+**

Manufacturing Capacity

**TOP500**

Global New Energy Enterprises

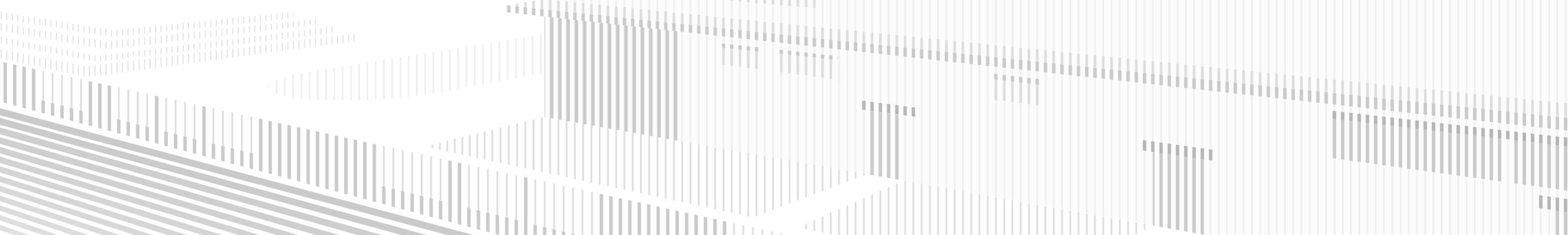

# COMPANY HISTORY

## 2005

Ginlong Technologies established in Ningbo, China

## 2006

One of the first inverters certified to UK G83

## 2009

First Asian string inverter to achieve USA UL1741 certification

## 2010

Second Asian inverter certified to AS4777/AS 3100

## 2011

Ginlong hosted IEC61400 second annual meeting

## 2015

Ginlong inverter installed on the Eiffel Tower in Paris

Achieved top 12 inverter sales ranking in Europe

Earned third place ranking in China PV string inverter brand value (2015-2016)

## 2016

Listed by Asia PV innovation

Awarded Top Brand PV inverters by EUPD Research (2016-2023)

Awarded Best Distribution Inverter Brand by PVBL

## 2017

Granted prestigious APVIA Technology Achievement Award (2017-2021)

## 2018

Single-phase string inverters ranked 2nd in global market shares (Wood Mackenzie)

## 2019

Ginlong (Solis) listed as a Public Company Stock Code: 300763.SZ

Ginlong (Solis) Ranked Third among Asian Brands by BloombergNEF Bankability

## 2020

Three-phase string inverters ranked 3rd in global market shares (Wood Mackenzie)

Ginlong Solis won PVBL 2019 Annual Top Global PV Brand Award

## 2021

National Enterprise Technology Center

Ranked among the top 500 global new energy companies

National technological innovation demonstration enterprise

Excellent after-sales service system certification

Sixth batch of individual champions in 2021 by (MIIT)

## 2022

No.3 PV Inverter Supplier Globally in Shipments in 2021

No.2 PV Inverter Supplier Among Listed Companies in Shipments in China

National laboratory qualification CNAS certification



GINLONG TECHNOLOGIES CO.,LTD



# 27 Service Centers

With 27 offices and service centers around the world, including the Australia, Brazil, China, Chile, France, Germany, India, Italy, Indonesia, Korea, Mexico, Myanmar, Malaysia, Netherlands, Philippines, Poland, Pakistan, Romania, South Africa, Spain, Sweden, Singapore, Turkey, Thailand, UK, USA and Vietnam, Solis has a well-established and expanding global presence.

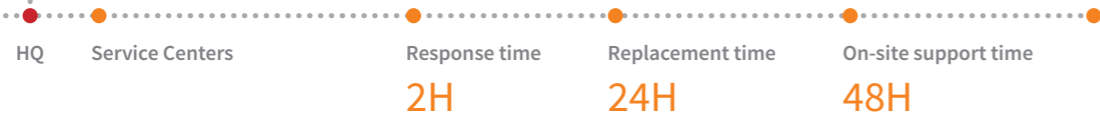

# GLOBAL REACH, LOCAL EXPERTISE

# CONTENTS

## P13

### Residential Solar PV Solutions

Solis residential string inverters are cost-effective and efficient residential green power leaders, providing smarter green power solutions for your residential buildings.

## P39

### Off-grid Energy Storage Solutions

The Solis off-grid inverter series is designed for areas without power grids or areas with frequent power outages or shutdowns/load-shedding. Supports parallel operation of up to 10 units and is compatible with oil generators. Ideal for household and small commercial applications Scenes.

## P27

### Residential Energy Storage Solutions

The Solis residential energy storage family, covers single-phase and three-phase application scenarios. It aims to provide energy storage solutions for PV systems to achieve the goal of residential zero-carbon green electricity. The power range covers 3kW - 10kW.

## P43

### Commercial & Industrial Solar PV Solutions

Solis' C&I string inverter product line is broad with a power range cover 25kW - 110kW, providing you with the best industry green power solutions.

## P61

### Utility Scale Solar PV Solutions

Solis has optimized and innovated the whole process of utility solar PV solutions, integrated PV system design, digital management, and IoT technology.

## P73

### SolisCloud: Intelligent Solar Energy System Monitoring

The SolisCloud intelligent monitoring system includes hardware and software products and is a comprehensive energy management solution. Hardware products, including data stick, data box, EPM and PLC, etc; transmit to SolisCloud online energy

## P69

### Export Power Management Solutions

In some countries, local regulations limit the amount of PV power that can be exported to the grid or allow no export. Solis offers two export limitation solutions for single and multiple inverters system.

management platform. Real-time monitoring, visualized management and remote O & M of residential, C&I and utility scale solar PV plants.

# Residential Solar PV Solutions



Solis residential string inverters are cost-effective and efficient green power leaders, providing smarter green power solutions for your residential buildings. A variety of models and solutions meet the needs of modern homes.

The portfolio includes single-phase and small three-phase string inverters, with a wide range of models, providing the best home green power solutions based on your application scenarios and specific needs. Solis Residential inverters are small and light, allowing for just one person to complete the installation. The overall design is sleek and modern, with low noise, particularly suitable for home installation without affecting people's daily activities. Via online or App, you can connect to SolisCloud for intelligent energy management. Simple operation and convenient. Solis residential solutions are technically advanced, flexible and simplify integration with digital home automation equipment and smart grids.

## Residential Solar PV Solution

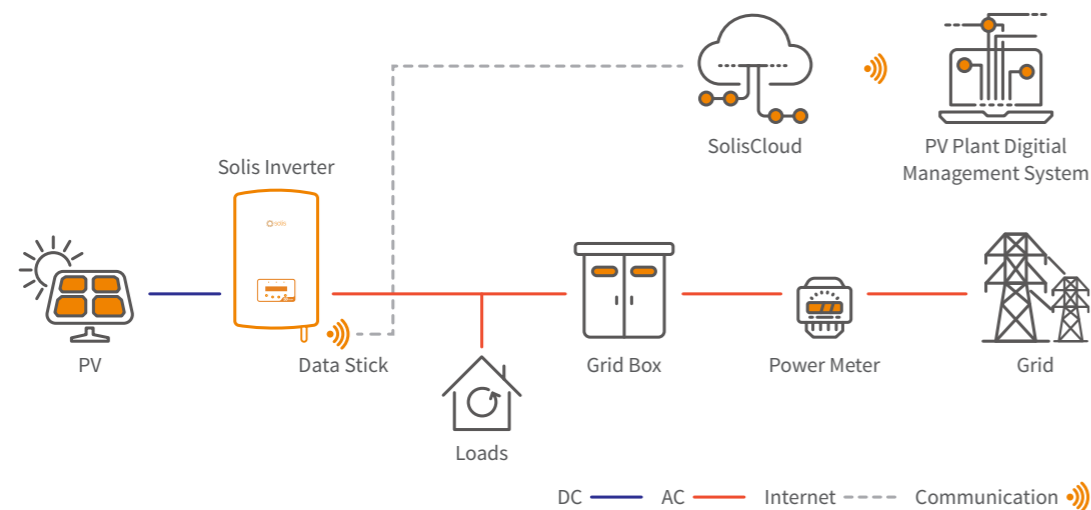

### Models:

S6-GR1P(0.7-3.6)K-M / S6-GR1P(2.5-6)K  
 S6-GR1P(7-8)K2 / S5-GR1P(7-10)K  
 S5-GR3P(3-20)K

### Output:

0.7 kW - 20 kW



## S6-GR1P(0.7-3.6)K-M

### Solis Mini Series Inverters

#### Features:

- Max. efficiency 97.3%
- String current up to 14A
- Super high frequency switching technology
- Wide voltage range and low startup voltage
- Precise MPPT algorithm
- Intergrated Export Power Manager (EPM)
- AFCI protection, proactively reduces fire risk
- Compact and lightweight
- Friendly and adaptable connection to the grid

#### Models:

S6-GR1P0.7K-M / S6-GR1P1K-M

S6-GR1P1.5K-M / S6-GR1P2K-M

S6-GR1P2.5K-M / S6-GR1P3K-M

S6-GR1P3.6K-M



360° View

## DATASHEET

### S6-GR1P(0.7-3.6)K-M

Models	0.7K	1K	1.5K	2K	2.5K	3K	3.6K
<b>Input DC</b>							
Recommended max. PV power	1.1 kW	1.5 kW	2.3 kW	3 kW	3.8 kW	4.5 kW	5.4 kW
Max. input voltage	600 V						
Rated voltage	200 V			330 V			
Start-up voltage	60 V			90 V			
MPPT voltage range	50-500 V			80-500 V			
Max. input current				14 A			19 A
Max. short circuit current				22 A			24 A
MPPT number/Max. input strings number				1/1			1/2
<b>Output AC</b>							
Rated output power	0.7 kW	1 kW	1.5 kW	2 kW	2.5 kW	3 kW	3.6 kW
Max. apparent output power	0.77 kVA	1.1 kVA	1.65 kVA	2.2 kVA	2.75 kVA	3.3 kVA	3.6 kVA
Max. output power	0.77 kW	1.1 kW	1.65 kW	2.2 kW	2.75 kW	3.3 kW	3.6 kW
Rated grid voltage	1/N/PE, 220 V / 230 V						
Rated grid frequency	50 Hz / 60 Hz						
Rated grid output current	3.2 A / 3.0 A	4.5 A / 4.3 A	6.8 A / 6.5 A	9.1 A / 8.7 A	11.4 A / 10.9 A	13.6 A / 13 A	16 A
Max. output current	4.4 A	5.2 A	8.1 A	10.5 A	13.3 A	15.7 A	16 A
Power factor	>0.99 (0.8 leading - 0.8 lagging)						
THDi	<3%						
<b>Efficiency</b>							
Max. efficiency	96.6%		96.6%	97.1%	97.1%		97.3%
EU efficiency	95.3%		95.4%	96.6%	96.7%		96.8%
<b>Protection</b>							
DC reverse-polarity protection				Yes			
Short circuit protection				Yes			
Output over current protection				Yes			
Surge protection				Yes			
Grid monitoring				Yes			
Anti-islanding protection				Yes			
Temperature protection				Yes			
Integrated AFCI (DC arc-fault circuit protection)				Yes <sup>(1)</sup>			
Integrated DC switch				Optional			
<b>General Data</b>							
Dimensions (W*H*D)				310*373*160 mm			
Weight				7.4 kg	7.7 kg		
Topology	Transformerless						
Self-consumption (night)	<1 W						
Operating ambient temperature range	-25 ~ +60°C						
Relative humidity	0-100%						
Ingress protection	IP66						
Cooling concept	Natural convection						
Max. operation altitude	4000 m						
Grid connection standard	G98 or G99, VDE-AR-N 4105 / VDE V 0124, EN 50549-1, VDE 0126 / UTE C 15 / VFR:2019, RD 1699 / RD 244 / UNE 206006 / UNE 206007-1, CEI 0-21, C10/11, NRS 097-2-1, EIFS 2018.2, IEC 62116, IEC 61727, IEC 60068, IEC 61683, EN 50530, MEA, PEA						
Safety/EMC standard	IEC/EN 62109-1/-2, IEC/EN 61000-6-1/-2/-3/-4						
<b>Features</b>							
DC connection	MC4 connector						
AC connection	Quick connection plug						
Display	LCD						
Communication	RS485, Optional: Wi-Fi, GPRS						

(1) Activation required.

## S6-GR1P(2.5-6)K

### Solis Single Phase Inverters

#### Features:

- Max. efficiency 97.7%
- String current up to 14A
- Super high frequency switching technology
- Wide voltage range and low startup voltage
- 2 MPPT design with precise MPPT algorithm
- Intergrated Export Power Manager (EPM)
- AFCI protection, proactively reduces fire risk
- Compact and lightweight
- Friendly and adaptable connection to the grid

#### Models:

S6-GR1P2.5K / S6-GR1P3K

S6-GR1P3.6K / S6-GR1P4K

S6-GR1P4.6K / S6-GR1P5K

S6-GR1P6K



360° View

## DATASHEET

### S6-GR1P(2.5-6)K

Models	2.5K	3K	3.6K	4K	4.6K	5K	6K
<b>Input DC</b>							
Recommended max. PV power	3.75 kW	4.5 kW	5.4 kW	6 kW	6.9 kW	7.5 kW	9 kW
Max. input voltage	550 V	600 V					
Rated voltage	250 V	330 V					
Start-up voltage	60 V	120 V					
MPPT voltage range	50-450 V	90-520 V					
Max. input current				14 A / 14 A			
Max. short circuit current				22 A / 22 A			
MPPT number/Max. input strings number				2/2			
<b>Output AC</b>							
Rated output power	2.5 kW	3 kW	3.6 kW	4 kW	4.6 kW	5 kW	6 kW
Max. apparent output power	2.8 kVA	3.3 kVA	4 kVA	4.4 kVA	5 kVA	5 kVA	6 kVA
Max. output power	2.8 kW	3.3 kW	4 kW	4.4 kW	5 kW	5 kW	6 kW
Rated grid voltage	1/N/PE, 220 V / 230 V						
Rated grid frequency	50 Hz / 60 Hz						
Rated grid output current	11.4 A / 10.9 A	13.6 A / 13.0 A	16.0 A / 15.7 A	18.2 A / 17.4 A	20.9 A / 20.0 A	22.7 A / 21.7 A	27.3 A
Max. output current	13.3 A	15.7 A	16.0 A	21.0 A	23.8 A	25.0 A	27.3 A
Power factor	>0.99 (0.8 leading - 0.8 lagging)						
THDi	<3%						
<b>Efficiency</b>							
Max. efficiency	97.3%	97.3%			97.6%	97.7%	
EU efficiency	96.5%	96.6%			97.1%	97.1%	
<b>Protection</b>							
DC reverse-polarity protection				Yes			
Short circuit protection				Yes			
Output over current protection				Yes			
Surge protection				Yes			
Grid monitoring				Yes			
Anti-islanding protection				Yes			
Temperature protection				Yes			
Integrated AFCI (DC arc-fault circuit protection)				Yes <sup>(1)</sup>			
Integrated DC switch				Optional			
<b>General Data</b>							
Dimensions (W*H*D)				310*543*160 mm			
Weight	11 kg	11.2 kg	12 kg				
Topology	Transformerless						
Self-consumption (night)	<1 W						
Operating ambient temperature range	-25 ~ +60°C						
Relative humidity	0-100%						
Ingress protection	IP66						
Cooling concept	Natural convection						
Max. operation altitude	4000 m						
Grid connection standard	G98 <sup>(2)</sup> or G99, VDE-AR-N 4105 / VDE V 0124, EN 50549-1, VDE 0126 / UTE C 15 / VFR:2019, RD 1699 / RD 244 / UNE 206006 / UNE 206007-1, CEI 0-21, C10/11, NRS 097-2-1, EIFS 2018.2, IEC 62116, IEC 61727, IEC 60068, IEC 61683, EN 50530, MEA, PEA						
Safety/EMC standard	IEC/EN 62109-1/-2, IEC/EN 61000-6-2/-3						
<b>Features</b>							
DC connection	MC4 connector						
AC connection	Quick connection plug						
Display	LCD						
Communication	RS485, Optional: Wi-Fi, GPRS						

(1) Activation required. (2) G98 for 2.5K-3.6K.

## S6-GR1P(7-8)K2

### Solis Single Phase Inverters

#### Features:

- Max. efficiency 97.7%
- String current up to 14A
- Wide voltage range and low startup voltage
- 2 MPPT design with precise MPPT algorithm
- Intergrated Export Power Manager (EPM)
- AFCI protection, proactively reduces fire risk
- Compact and lightweight
- Friendly and adaptable connection to the grid

#### Models:

S6-GR1P7K2

S6-GR1P8K2



## DATASHEET

## S6-GR1P(7-8)K2

Models	7K	8K
<b>Input DC</b>		
Recommended max. PV power	10.5 kW	12 kW
Max. input voltage	600 V	
Rated voltage	330 V	
Start-up voltage	90 V	
MPPT voltage range	90-520 V	
Max. input current	14 A / 28 A	
Max. short circuit current	19.5 A / 35 A	
MPPT number/Max. input strings number	2/3	
<b>Output AC</b>		
Rated output power	7 kW	8 kW
Max. apparent output power	7.7 kVA	8 kVA
Max. output power	7.7 kW	8 kW
Rated grid voltage	1/N/PE, 220 V / 230 V	
Rated grid frequency	50 Hz / 60 Hz	
Rated grid output current	31.8 A / 30.4 A	36.4 A / 34.8 A
Max. output current	35 A	36.4 A
Power factor	>0.99 (0.8 leading - 0.8 lagging)	
THDi	<3%	
<b>Efficiency</b>		
Max. efficiency	97.7%	
EU efficiency	96.8%	
<b>Protection</b>		
DC reverse-polarity protection	Yes	
Short circuit protection	Yes	
Output over current protection	Yes	
Surge protection	Yes	
Grid monitoring	Yes	
Anti-islanding protection	Yes	
Temperature protection	Yes	
Integrated AFCI (DC arc-fault circuit protection)	Yes <sup>(1)</sup>	
Integrated DC switch	Optional	
<b>General Data</b>		
Dimensions (W*H*D)	310*543*180 mm	
Weight	13 kg	
Topology	Transformerless	
Self-consumption (night)	<1 W	
Operating ambient temperature range	-25 ~ +60°C	
Relative humidity	0-100%	
Ingress protection	IP66	
Cooling concept	Natural convection	
Max. operation altitude	4000 m	
Grid connection standard	G98 or G99, EN 50549-1, RD 1699 / RD 244 / UNE 206006 / UNE 206007-1, IEC 62116, IEC 61727, IEC60068, IEC 61683, EN 50530	
Safety/EMC standard	IEC/EN 62109-1/-2, IEC/EN 61000-6-1/-2/-3/-4	
<b>Features</b>		
DC connection	MC4 connector	
AC connection	Quick connection plug	
Display	LCD	
Communication	RS485, Optional: Wi-Fi, GPRS	

(1) Activation required.

## S5-GR1P(7-10)K

### Solis Single Phase Inverters

#### Features:

- Max. efficiency 98.0%
- Max. input current 14A
- Super high frequency switching technology
- Wide voltage range and low startup voltage
- 3 MPPT design with precise MPPT algorithm
- AFCI protection, proactively reduces fire risk
- Compact and lightweight
- Friendly and adaptable connection to the grid

#### Models:

S5-GR1P7K / S5-GR1P8K

S5-GR1P9K / S5-GR1P10K



## DATASHEET

## S5-GR1P(7-10)K

Models	7K	8K	9K	10K
<b>Input DC</b>				
Recommended max. PV power	10.5 kW	12 kW	13.5 kW	15 kW
Max. input voltage	600 V			
Rated voltage	330 V			
Start-up voltage	120 V			
MPPT voltage range	100-500 V			
Max. input current	14 A / 14 A / 14 A			
Max. short circuit current	22 A / 22 A / 22 A			
MPPT number/Max. input strings number	3 / 3			
<b>Output AC</b>				
Rated output power	7 kW	8 kW	9 kW	10 kW
Max. apparent output power	7.7 kVA	8.8 kVA	9.9 kVA	10 kVA
Max. output power	7.7 kW	8.8 kW	9.9 kW	10 kW
Rated grid voltage	1/N/PE, 220 V / 230 V			
Rated grid frequency	50 Hz / 60 Hz			
Rated grid output current	31.8 A / 30.4 A	36.4 A / 34.8 A	40.9 A / 39.1 A	45.5 A / 43.5 A
Max. output current	33.7 A	36.6 A	41.3 A	45.9 A
Power factor	>0.99 (0.8 leading - 0.8 lagging)			
THDi	<3%			
<b>Efficiency</b>				
Max. efficiency	98.0%			
EU efficiency	97.1%			
<b>Protection</b>				
DC reverse-polarity protection	Yes			
Short circuit protection	Yes			
Output over current protection	Yes			
Surge protection	Yes			
Grid monitoring	Yes			
Anti-islanding protection	Yes			
Temperature protection	Yes			
Integrated AFCI (DC arc-fault circuit protection)	Yes <sup>(1)</sup>			
Integrated DC switch	Optional			
<b>General Data</b>				
Dimensions (W*H*D)	333*579*253 mm			
Weight	18.5 kg			
Topology	Transformerless			
Self-consumption (night)	<1 W			
Operating ambient temperature range	-25 ~ +60°C			
Relative humidity	0-100%			
Ingress protection	IP66			
Cooling concept	Natural convection			
Max. operation altitude	4000 m			
Grid connection standard	G99, EN 50549-1, IEC 62116, IEC 61727, IEC60068, IEC 61683, EN 50530			
Safety/EMC standard	IEC/EN 62109-1/-2, IEC/EN 61000-6-1/-2/-3/-4			
<b>Features</b>				
DC connection	MC4 connector			
AC connection	OT Terminal			
Display	LCD			
Communication	RS485, Optional: Wi-Fi, GPRS			

(1) Activation required.

## S5-GR3P(3-20)K

### Solis Three Phase Inverters

#### Efficient

- Max. efficiency 98.7%
- String current up to 16A
- Wide voltage range and low startup voltage

#### Smart

- Supports export power control
- Supports RS485, WiFi, GPRS
- Scan to register on SolisCloud, supports remote upgrade and control

#### Safe

- IP66
- AFCI protection, proactively reduces fire risk
- Automatic voltage stabilization technology in weak grid conditions

#### Economic

- Compact design, simple installation and maintenance
- > 150% DC/AC ratio
- Supports high power modules for lower installation costs

#### Models:

- S5-GR3P3K / S5-GR3P4K
- S5-GR3P5K / S5-GR3P6K
- S5-GR3P8K / S5-GR3P9K
- S5-GR3P10K / S5-GR3P12K
- S5-GR3P13K / S5-GR3P15K
- S5-GR3P17K / S5-GR3P20K



## DATASHEET

## S5-GR3P(3-20)K

Models	3K	4K	5K	6K	8K	9K	10K	12K	13K	15K	17K	20K
<b>Input DC</b>												
Recommended max. PV power	4.5 kW	6 kW	7.5 kW	9 kW	12 kW	13.5 kW	15 kW	18 kW	19.5 kW	22.5 kW	25.5 kW	30 kW
Max. input voltage	1100 V											
Rated voltage	600 V											
Start-up voltage	180 V											
MPPT voltage range	160-1000 V											
Max. input current	16 A / 16 A						32 A / 32 A					
Max. short circuit current	20 A / 20 A						40 A / 40 A					
MPPT number/Max. input strings number	2/2						2/4					
<b>Output AC</b>												
Rated output power	3 kW	4 kW	5 kW	6 kW	8 kW	9 kW	10 kW	12 kW	13 kW	15 kW	17 kW	20 kW
Max. apparent output power	3.3 kVA	4.4 kVA	5.5 kVA	6.6 kVA	8.8 kVA	9.9 kVA	11 kVA	13.2 kVA	14.3 kVA	16.5 kVA	18.7 kVA	22 kVA
Max. output power	3.3 kW	4.4 kW	5.5 kW	6.6 kW	8.8 kW	9.9 kW	11 kW	13.2 kW	14.3 kW	16.5 kW	18.7 kW	22 kW
Rated grid voltage	3/N/PE, 220 V / 380 V, 230 V / 400 V											
Rated grid frequency	50 Hz / 60 Hz											
Rated grid output current	4.6 A / 4.3 A	6.1 A / 5.8 A	7.6 A / 7.2 A	9.1 A / 8.7 A	12.2 A / 11.5 A	13.7 A / 13.0 A	15.2 A / 14.4 A	18.2 A / 17.3 A	19.8 A / 18.8 A	22.8 A / 21.7 A	25.8 A / 24.6 A	30.4 A / 28.9 A
Max. output current	4.7 A	6.4 A	7.9 A	9.5 A	12.7 A	14.3 A	15.9 A	19.1 A	20.7 A	23.8 A	27 A	31.8 A
Power factor	>0.99 (0.8 leading - 0.8 lagging)											
THDi	<2%											
<b>Efficiency</b>												
Max. efficiency	98.3%			98.5%			98.6%			98.7%		
EU efficiency	97.7%			97.9%			98.0%			98.1%		
<b>Protection</b>												
DC reverse-polarity protection	Yes											
Short circuit protection	Yes											
Output over current protection	Yes											
Surge protection	Yes											
Grid monitoring	Yes											
Anti-islanding protection	Yes											
Temperature protection	Yes											
Integrated AFCI (DC arc-fault circuit protection)	Yes <sup>(1)</sup>											
Integrated DC switch	Optional											
<b>General Data</b>												
Dimensions (W*H*D)	310*563*219 mm											
Weight	17.8 kg						18.8 kg			20 kg		
Topology	Transformerless											
Self-consumption (night)	<1 W											
Operating ambient temperature range	-25 ~ +60°C											
Relative humidity	0-100%											
Ingress protection	IP66											
Cooling concept	Natural convection						Intelligent redundant fan-cooling					
Max. operation altitude	4000 m											
Grid connection standard	G99, VDE-AR-N 4105 / VDE V 0124, EN 50549-1, VDE 0126 / UTE C 15 / VFR:2019, RD 1699 / RD 244 / UNE 206006 / UNE 206007-1, CEI 0-21, C10/11, NRS 097-2-1, EIFS 2018.2, IEC 62116, IEC 61727, IEC 60068, IEC 61683, EN 50530											
Safety/EMC standard	IEC/EN 62109-1/-2, IEC/EN 61000-6-1/-2/-3/-4											
<b>Features</b>												
DC connection	MC4 connector											
AC connection	Quick connection plug											
Display	LCD											
Communication	RS485, Optional: Wi-Fi, GPRS											

(1) Activation required.

# Residential Power Plant Case Study



📍 Finland  
⚡ 6.7kW 📦 S5-GR3P10k



📍 USA  
⚡ 16kW 📦 Solis-(2.5-6)K-4G-US

## Microgrid Project in Hebei Province

This microgrid project in Hebei province uses Solis-3P(12-25)K-5G and Solis-(25-50)K-5G inverters. Through the configuration of an energy storage system, the project adopts the mode of "Self-use, surplus electricity exported & sold back to the grid". This has realized consumption of new green energy to the region and delivers a stable income of about 1.6 million yuan annually.

In addition, the system is monitored in real-time via the SolisCloud platform which offers intelligent digital functions, online system control, along with accurate operation and maintenance. This in turn makes power station management more efficient, convenient and cost effective.

This project demonstrates the technological progress and expansion of the solar industry, accelerating the development of clean, low-carbon energy.



📍 Australia  
⚡ 8.2kW 📦 Solis-1P(2.5-6)K-4G



📍 UK  
⚡ 2.8kW 📦 S6-GR1P(2.5-6)K



📍 China  
⚡ 2.7MW  
📦 GCI-3P(12-25)K-5G



# Residential Energy Storage Solutions



The Solis residential energy storage family has abundant products, covering single-phase and three-phase application scenarios. It aims to provide energy storage solutions for PV systems to achieve the goal of real residential zero-carbon green electricity. The power range covers 3kW - 10kW. We can according to the requirements of your project application scenarios, rely on our flexible products to provide you with the best residential zero-carbon green power solutions.

**Models:**

- S5-EH1P(3-6)K-L
- S6-EH1P(3-6)K-L
- RHI-3P(5-10)K-HVES-5G
- S6-EH3P(5-10)K-H
- RAI-3K-48ES-5G

**Output:**

3 kW ~ 10 kW

● Residential Energy Storage Solution - S5/RHI series

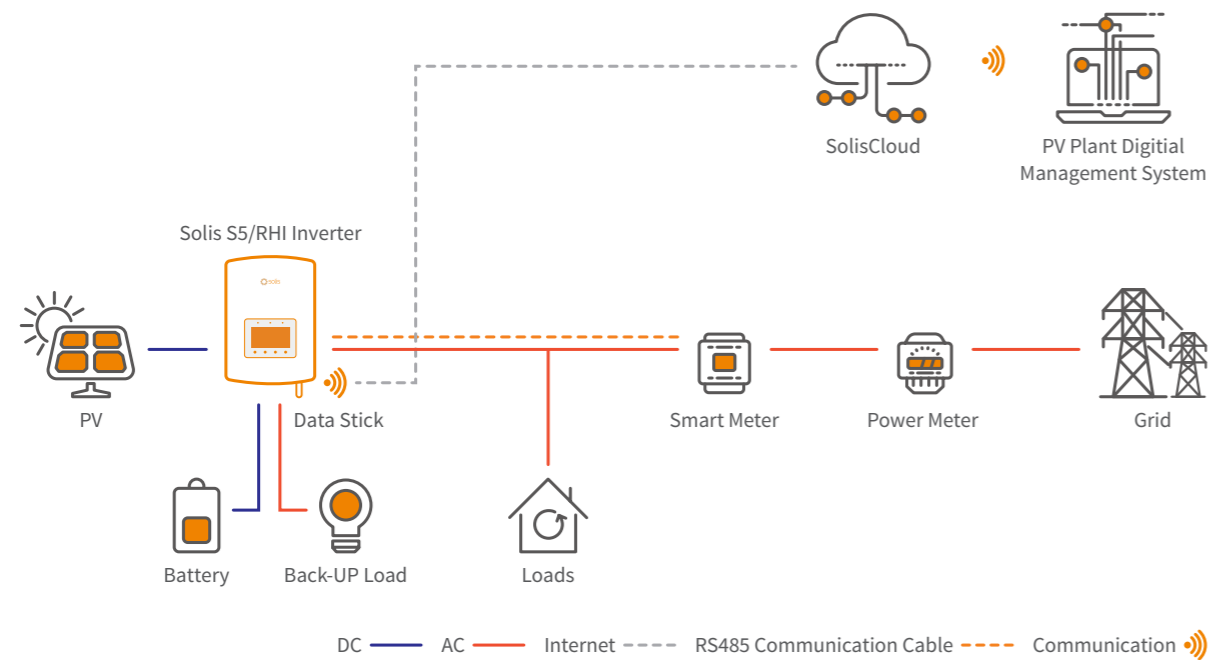

● Residential Energy Storage Solution - S6 series

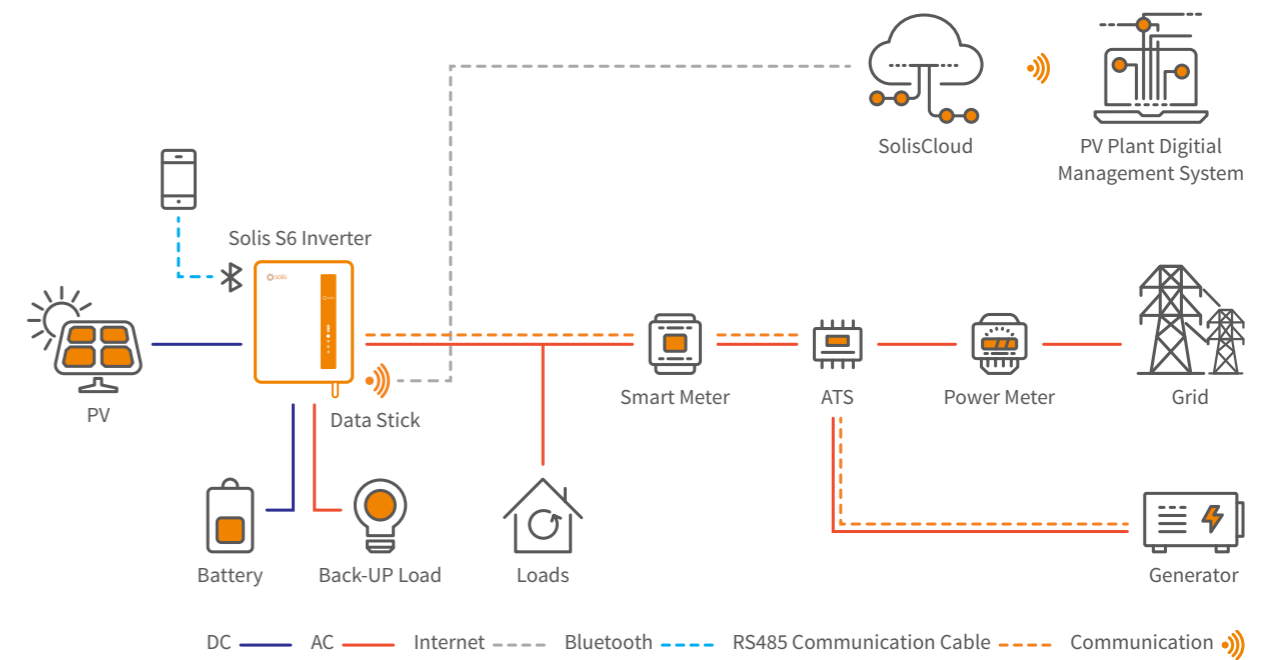

## S5-EH1P(3-6)K-L

### Solis Energy Storage Inverters

#### Features:

- Max. string input current 15A
- Uninterrupted power supply, 20ms reaction
- 5kW backup power to support more important loads
- Multiple working modes to make maximize self-consumption, increase benefit
- Higher charge-discharge efficiency, improving the economic benefits
- AFCI protection, proactively reduces fire risk
- Fanless design, long lifespan
- Compatible with lithium & lead-acid batteries, increased more choice in different markets
- Intelligent EMS function, improving battery's reliability
- With high-frequency isolation technology, making system safer and long lifespan
- 24-hour fully intelligent energy management, Real-time grasp of PV plant status
- Remotely control & upgrade function, making digital power plant maintenance at your fingertips

#### Models:

S5-EH1P3K-L / S5-EH1P3.6K-L

S5-EH1P4.6K-L / S5-EH1P5K-L

S5-EH1P6K-L



## DATASHEET

## S5-EH1P(3-6)K-L

Models	3K	3.6K	4.6K	5K	6K
<b>Input DC (PV side)</b>					
Recommended max. PV power	4.8 kW	5.7 kW	8 kW	8 kW	8 kW
Max. input voltage	600 V				
Rated voltage	330 V				
Start-up voltage	120 V				
MPPT voltage range	90-520 V				
Max. input current	15 A / 15 A				
Max. short circuit current	22.5 A / 22.5 A				
MPPT number/Max. input strings number	2/2				
<b>Battery</b>					
Battery type	Li-ion / Lead-acid				
Battery voltage range	42 - 58 V				
Battery capacity	50 - 2000 Ah				
Max. charge / discharge power	3 kW		5 kW		
Max. charge / discharge current	62.5 A		100 A		
Communication	CAN				
<b>Output AC (Back-up)</b>					
Rated output power	3 kW		5 kW		
Max. apparent output power	4.5 kVA, 10 sec		7 kVA, 10 sec		
Back-up switch time	<20 ms				
Rated output voltage	1/N/PE, 220 V / 230 V				
Rated frequency	50 Hz / 60 Hz				
Rated output current	14 A / 13.5 A		23 A / 22 A		
THDv (@linear load)	<2%				
<b>Input AC (Grid side)</b>					
Input voltage range	187-265 V				
Max. input current	20.5 A / 20 A	25 A / 23.5 A	31.5 A / 30 A	34.5 A / 33 A	34.5 A / 33 A
Frequency range	45-55 Hz / 55-65 Hz				
<b>Output AC (Grid side)</b>					
Rated output power	3 kW	3.6 kW	4.6 kW	5 kW	6 kW
Max. apparent output power	3.3 kVA	4 kVA	4.6 kVA	5.5 kVA	6.6 kVA
Operation phase	1/N/PE				
Rated grid voltage	220 V / 230 V				
Rated grid frequency	50 Hz / 60 Hz				
Rated grid output current	13.7 A / 13.1 A	16.4 A / 15.7 A	20.9 A / 20 A	22.8 A / 21.7 A	27.3 A / 26.1 A
Max. output current	15 A	18.5 A	21 A	25 A	30 A
Power factor	>0.99 (0.8 leading - 0.8 lagging)				
THDi	<2%				
<b>Efficiency</b>					
Max. efficiency	>97.1%				
EU efficiency	>96.5%				
<b>Protection</b>					
DC reverse-polarity protection	Yes				
Short circuit protection	Yes				
Output over current protection	Yes				
Surge protection	DC Type II / AC Type II				
Ground fault monitoring	Yes				
Integrated AFCI (DC arc-fault circuit protection)	Yes <sup>(1)</sup>				
Protection class/Over voltage category	I/II				
<b>General Data</b>					
Dimensions (W*H*D)	333*505*249 mm				
Weight	18.3 kg				
Topology	High frequency isolation (for battery)				
Operating ambient temperature range	-25 ~ +60°C				
Ingress protection	IP65				
Cooling concept	Natural convection				
Max. operation altitude	3000 m				
Grid connection standard	G98 or G99, VDE-AR-N 4105/VDE V 0124, EN 50549-1, VDE 0126/UTE C 15/VFR:2019, RD 1699/RD 244/UNE 206006/UNE 206007-1, CEI 0-21, C10/11, NRS 097-2-1, EIFS 2018.2, IEC 62116, IEC 61727, IEC 60068, IEC 61683, EN 50530, MEA, PEA				
Safety/EMC standard	IEC/EN 62109-1/-2, EN 61000-6-2/-3				
<b>Features</b>					
DC connection	MC4 connector				
AC connection	Quick connection plug				
Display	7.0"LCD color screen display				
Communication	RS485, Optional: Wi-Fi, GPRS				

(1) Activation required.



## S6-EH1P(3-6)K-L

### Solis Energy Storage Inverters

#### Highly Flexible

- Integrated 2 MPPTs, suitable for residential rooftop installations with multiple array orientations
- Compatible with multiple brands of battery models giving customers multiple battery options

#### Intelligent Function

- Supports pure off grid applications with generator communication support
- Multiple working modes to meet different use case scenarios
- Controllable and Upgradeable via the SolisCloud App to avoid site visits

#### Safe and Reliable

- Safety protection with integrated AFCI function, which actively detects arc faults in the PV Array
- Natural convection design without external fans

#### Outstanding Performance

- Up to 16A of MPPT current input to support 182mm solar panels
- Supports 1.6 DC:AC ratio to connect more PV capacity to the energy storage system
- Up to 125A/6kW max charge/discharge rating with industry highest level 6kW of backup loads support capability
- UPS level switching time (<10ms) supporting critical loads all the time
- High PV charge efficiency to prevent excess PV loss

#### Models:

S6-EH1P3K-L / S6-EH1P3.6K-L

S6-EH1P4.6K-L / S6-EH1P5K-L

S6-EH1P6K-L



### DATASHEET

### S6-EH1P(3-6)K-L

Models	3K	3.6K	4.6K	5K	6K
<b>Input DC (PV side)</b>					
Recommended max. PV power	4.8 kW	5.7 kW	7 kW	8 kW	9.6 kW
Max. input voltage	600 V				
Rated voltage	330 V				
Start-up voltage	90 V				
MPPT voltage range	90-520 V				
Max. input current	16 A / 16 A				
Max. short circuit current	24 A / 24 A				
MPPT number/Max. input strings number	2/2				
<b>Battery</b>					
Battery type	Li-ion / Lead-acid				
Battery voltage range	42 - 58 V				
Battery capacity	50 - 2000 Ah				
Max. charge / discharge power	3 kW	3.6 kW	4.6 kW	5 kW	6 kW
Max. charge / discharge current	62.5 A	75 A	100 A	105 A	125 A
Communication	CAN				
<b>Output AC (Back-up)</b>					
Rated output power	3 kW	3.6 kW	4.6 kW	5 kW	6 kW
Max. apparent output power	4.2 kVA, 60 sec	5 kVA, 60 sec	6.4 kVA, 60 sec	7 kVA, 60 sec	8 kVA, 60 sec
Back-up switch time	<10 ms				
Rated output voltage	1/N/PE, 220 V / 230 V				
Rated frequency	50 Hz / 60 Hz				
Max. output current	21.8 A	26.2 A	33.4 A	36.5 A	40 A
THDv (@linear load)	<2%				
<b>Input AC (Grid side)</b>					
Input voltage range	187-253 V				
Max. input current	20.5 A	24.6 A	31.4 A	34.1 A	40 A
Frequency range	45-55 Hz / 55-65 Hz				
<b>Output AC (Grid side)</b>					
Rated output power	3 kW	3.6 kW	4.6 kW	5 kW	6 kW
Max. apparent output power	3.3 kVA	4 kVA	4.6 kVA	5.5 kVA	6.6 kVA
Operation phase	1/N/PE				
Rated grid voltage	220 V / 230 V				
Rated grid frequency	50 Hz / 60 Hz				
Rated grid output current	13.6 A / 13 A	16.4 A / 15.7 A	20.9 A / 20 A	22.7 A / 21.7 A	27.3 A / 26.1 A
Max. output current	15 A	18.2 A	21 A	25 A	30 A
Power factor	>0.99 (0.8 leading - 0.8 lagging)				
THDi	<2%				
<b>Efficiency</b>					
Max. efficiency	> 97.5%				
EU efficiency	> 96.2%				
BAT charged by PV Max. efficiency	> 94.9%				
BAT charged/discharged to AC Max. efficiency	> 94.33%/93.51%				
<b>Protection</b>					
DC reverse-polarity protection	Yes				
Ground fault monitoring	Yes				
Integrated AFCI (DC arc-fault circuit protection)	Yes <sup>(1)</sup>				
Protection class/Over voltage category	I/II				
<b>General Data</b>					
Dimensions (W*H*D)	405*480*205 mm				
Weight	24.2 kg				
Topology	High frequency isolation (for battery)				
Operating ambient temperature range	-25 ~ +60°C				
Ingress protection	IP66				
Cooling concept	Natural convection				
Max. operation altitude	4000 m				
Grid connection standard	G98 or G99, VDE-AR-N 4105 / VDE V 0124, EN 50549-1, VDE 0126 / UTE C 15 / VFR:2019, RD 1699 / RD 244 / UNE 206006 / UNE 206007-1, CEI 0-21, C10/11, NRS 097-2-1, EIFS 2018.2, IEC 62116, IEC 61727, IEC 60068, IEC 61683, EN 50530, MEA, PEA				
Safety/EMC standard	IEC/EN 62109-1/-2, EN 61000-6-1/-2/-3/-4				
<b>Features</b>					
DC connection	MC4 connector				
AC connection	Quick connection plug				
Display	LED + APP				
Communication	RS485, CAN, Optional: Wi-Fi, GPRS, LAN				

(1) Activation required.

## RHI-3P(5-10)K-HVES-5G

### Solis Energy Storage Inverters

#### Features:

- Max. efficiency 98.4%
- 2 MPPT and 4 DC input; Max 26A DC input current
- 3 operating modes (self-consumption; time-of-use; off-grid back-up) & programmable energy management
- Power supply can be switched automatically and switching time within 40ms
- Ensures AC backup for up to 10kW of continuous power and 16kVA of peak power
- Time of use shifting and peak shaving capabilities to grid
- AFCI protection, proactively reduces fire risk
- Intelligent EMS function
- Support three-phase imbalance on backup output port
- 24-hour fully intelligent energy management, Real-time grasp of PV plant status
- Remotely control & upgrade function, making digital power plant maintenance at your fingertips

#### Models:

RHI-3P5K-HVES-5G / RHI-3P6K-HVES-5G

RHI-3P8K-HVES-5G / RHI-3P10K-HVES-5G



360° View

## DATASHEET

### RHI-3P(5-10)K-HVES-5G

Models	5K	6K	8K	10K
<b>Input DC (PV side)</b>				
Recommended max. PV power	8 kW	9.6 kW	12.8 kW	16 kW
Max. input voltage	1000 V			
Rated voltage	600 V			
Start-up voltage	160 V			
MPPT voltage range	200-850 V			
Max. input current	13 A / 13 A		26 A / 13 A	
Max. short circuit current	16.5 A / 16.5 A		32.5 A / 16.5 A	
MPPT number/Max. input strings number	2/2		2/3	
<b>Battery</b>				
Battery type	Li-ion			
Battery voltage range	160-600 V			
Max. charge / discharge power	5 kW	6 kW	8 kW	10 kW
Max. charge / discharge current	25 A			
Communication	CAN			
<b>Output AC (Grid side)</b>				
Rated output power	5 kW	6 kW	8 kW	10 kW
Max. apparent output power	5.5 kVA	6.6 kVA	8.8 kVA	10 kVA
Operation phase	3/N/PE			
Rated grid voltage	380 V / 400 V			
Rated grid frequency	50 Hz / 60 Hz			
Rated grid output current	7.6 A / 7.3 A	9.2 A / 8.7 A	12.2 A / 11.6 A	15.2 A / 14.5 A
Max. output current	8.4 A	10 A	13.4 A	16.7 A
Power factor	>0.99 (0.8 leading - 0.8 lagging)			
THDi	<2%			
<b>Output AC (Back-up)</b>				
Rated output power	5 kW	6 kW	8 kW	10 kW
Peak apparent output power	10 kVA, 60 sec	12 kVA, 60 sec	16 kVA, 60 sec	16 kVA, 60 sec
Back-up switch time	< 40 ms			
Rated output voltage	3/N/PE, 380 V / 400 V			
Rated frequency	50 Hz / 60 Hz			
Rated output current	7.6 A / 7.3 A	9.2 A / 8.7 A	12.2 A / 11.6 A	15.2 A / 14.5 A
THDv (@linear load)	<2%			
<b>Efficiency</b>				
Max. efficiency	98.4%			
EU efficiency	97.7%			
MPPT efficiency	99.9%			
Battery charge/discharge efficiency	97.5%			
<b>Protection</b>				
Anti-islanding protection	Yes			
Output over current protection	Yes			
Short circuit protection	Yes			
Integrated AFCI (DC arc-fault circuit protection)	Yes <sup>(1)</sup>			
Integrated DC switch	Optional			
DC reverse-polarity protection	Yes			
PV over voltage protection	Yes			
Battery reverse protection	Yes			
<b>General Data</b>				
Dimensions (W*H*D)	535*455*185 mm			
Weight	25.1 kg			
Topology	Transformerless			
Standby consumption	<15 W			
Operating ambient temperature range	-25 ~ +60°C			
Relative humidity	0-100%			
Ingress protection	IP65			
Cooling concept	Natural convection			
Max. operation altitude	4000 m			
Grid connection standard	G98 or G99, VDE-AR-N 4105 / VDE V 0124, EN 50549-1, VDE 0126 / UTE C 15/VFR:2019, RD 1699/RD 244 / UNE 206006 / UNE 206007-1, CEI 0-21, C10/11, NRS 097-2-1, EIFS 2018.2, IEC 62116, IEC 61727, IEC 60068, IEC 61683, EN 50530, MEA, PEA			
Safety/EMC standard	IEC/EN 62109-1/-2, IEC/EN 61000-6-1/-3			
<b>Features</b>				
DC connection	MC4 connector			
AC connection	Quick connection plug			
Display	LCD			
Communication	RS485, Optional: Wi-Fi, GPRS			

(1) Activation required.

## S6-EH3P(5-10)K-H

### Solis Energy Storage Inverters

#### Highly Flexible

- Integrated 3 to 4 MPPTs, suitable for residential rooftop installations with multiple array orientations
- Supports Unbalanced and Half-Wave Loads on the Grid Port and on the Backup Port
- Compatible with multiple brands of battery models giving customers multiple battery options

#### Intelligent Function

- Supports pure off grid applications with generator communication support
- Multiple working modes to meet different use case scenarios
- Controllable and Upgradeable via the SolisCloud App to avoid site visits

#### Safe and Reliable

- Safety protection with integrated AFCI function, which actively detects arc faults in the PV Array
- Natural convection design without external fans

#### Outstanding Performance

- Up to 16A of MPPT current input to support 182mm solar panels
- Supports 1.6 DC:AC ratio to connect more PV capacity to the energy storage system
- Up to 50A/10kW max charge/discharge rating with industry highest level 10kW of backup loads support capability
- UPS level switching time (<10ms) supporting critical loads all the time
- High PV charge efficiency to prevent excess PV loss

#### Models:

S6-EH3P5K-H / S6-EH3P6K-H

S6-EH3P8K-H / S6-EH3P10K-H



360° View

• Monitoring Portal – [www.soliscloud.com](http://www.soliscloud.com) or SolisCloud App • Compatible Batteries – Check online at [www.solisinverters.com](http://www.solisinverters.com)

### DATASHEET

### S6-EH3P(5-10)K-H

Models	5K	6K	8K	10K
<b>Input DC (PV side)</b>				
Recommended max. PV power	8 kW	9.6 kW	12.8 kW	16 kW
Max. input voltage	1000 V			
Rated voltage	600 V			
Start-up voltage	160 V			
MPPT voltage range	200-850 V			
Max. input current	16 A / 16 A / 16 A		16 A / 16 A / 16 A / 16 A	
Max. short circuit current	24 A / 24 A / 24 A		24 A / 24 A / 24 A / 24 A	
MPPT number/Max. input strings number	3/3		4/4	
<b>Battery</b>				
Battery type	Li-ion			
Battery voltage range	120-600 V			
Max. charge / discharge power	5 kW	6 kW	8 kW	10 kW
Max. charge / discharge current	25 A		50 A	
Communication	CAN/RS485			
<b>Output AC (Grid side)</b>				
Rated output power	5 kW	6 kW	8 kW	10 kW
Max. apparent output power	5.5 kVA	6.6 kVA	8.8 kVA	11 kVA
Rated grid voltage	3/N/PE, 380 V / 400 V			
Rated grid frequency	50 Hz / 60 Hz			
Rated grid output current	7.6 A / 7.2 A	9.1 A / 8.7 A	12.2 A / 11.5 A	15.2 A / 14.4 A
Max. output current	8.4 A / 7.9 A	10 A / 9.6 A	13.4 A / 12.7 A	16.7 A / 15.8 A
Power factor	>0.99 (0.8 leading - 0.8 lagging)			
THDi	<3%			
<b>Input AC (Grid side)</b>				
Max. input power	7.5 kW	9 kW	12 kW	15 kW
Rated input current	11.4 A	13.8 A	18.2 A	22.8 A
Rated input voltage	3/N/PE, 380 V / 400 V			
Rated input frequency	50 Hz / 60 Hz			
<b>Output AC (Back-up)</b>				
Rated output power	5 kW	6 kW	8 kW	10 kW
Max. apparent output power	8 kVA, 60 sec	9.6 kVA, 60 sec	12.8 kVA, 60 sec	16 kVA, 60 sec
Back-up switch time	<10 ms			
Rated output voltage	3/N/PE, 380 V / 400 V			
Rated frequency	50 Hz / 60 Hz			
Rated output current	7.6 A / 7.2 A	9.1 A / 8.7 A	12.2 A / 11.5 A	15.2 A / 14.4 A
THDv (@linear load)	<2%			
<b>Efficiency</b>				
Max. efficiency	97.87%	97.91%	98.03%	98.04%
EU efficiency	96.77%	97.1%	97.41%	97.51%
BAT charged by PV Max. efficiency	98.37%	98.45%	98.22%	98.31%
BAT charged/discharged to AC Max. efficiency	97.32%	97.34%	97.5%	97.5%
<b>Protection</b>				
Anti-islanding protection	Yes			
Output over current protection	Yes			
Short circuit protection	Yes			
Integrated AFCI (DC arc-fault circuit protection)	Yes <sup>(1)</sup>			
Integrated DC switch	Yes			
DC reverse-polarity protection	Yes			
PV over voltage protection	Yes			
Battery reverse protection	Yes			
<b>General Data</b>				
Dimensions (W*H*D)	600*500*230 mm			
Weight	32.6 kg			
Topology	Transformerless			
Self-consumption (night)	<25 W			
Operating ambient temperature range	-25 ~ +60°C			
Ingress protection	IP66			
Cooling concept	Natural convection			
Max. operation altitude	4000 m			
Grid connection standard	G98 or G99, VDE-AR-N 4105 / VDE V 0124, EN 50549-1, VDE 0126 / UTE C 15/VFR:2019, RD 1699/RD 244 / UNE 206006 / UNE 206007-1, CEI 0-21, C10/11, NRS 097-2-1, EIFS 2018.2, IEC 62116, IEC 61727, IEC 60068, IEC 61683, EN 50530, MEA, PEA			
Safety/EMC standard	IEC/EN 62109-1/-2, IEC/EN 61000-6-1/-3			
<b>Features</b>				
PV connection	MC4 connector			
Battery connection	Quick connection plug			
AC connection	Quick connection plug			
Display	LED + Bluetooth + APP			
Communication	CAN, RS485, Ethernet, Optional: Wi-Fi, Cellular, LAN			

(1) Activation required.

**RAI-3K-48ES-5G****Solis Energy Storage Inverters****Features:**

- Uninterrupted power supply, 20ms reaction
- Compatible with both lead-acid battery and li-ion battery
- Compatible with any existing grid-tied PV system, option to upgrade
- Off-grid backup function
- EPS function
- Intelligent EMS function
- Intelligent debugging APP which support one-click inverter configuration
- Various work mode for different application scenario
- Natural cooling without external fan

**Models:**

RAI-3K-48ES-5G

**DATASHEET****RAI-3K-48ES-5G**

Models	3K
<b>Output AC (Grid side)</b>	
Rated output power	3 kW
Max. output power	3 kW
Max. apparent output power	3.3 kVA
Operation phase	1/N/PE
Rated grid voltage	220 V / 230 V
Grid voltage range	184-264 V
Rated grid frequency	50 Hz / 60 Hz
Rated grid output current	13.6 A / 13 A
Max. output current	20 A
Power factor	>0.99 (0.8 leading - 0.8 lagging)
THDi	<3%
<b>Battery</b>	
Battery type	Li-ion / Lead-acid
Battery voltage range	40-60 V
Battery capacity	50-2000 Ah
Max. charge / discharge current	60 A
Communication	CAN
<b>Output AC (Back-up)</b>	
Rated output power	3kW (Requires battery voltage higher than 55 V)
Max. apparent output power	4.5 kVA
Back-up switch time	<20 ms
Rated output voltage	1/N/PE, 220 V / 230 V
Rated frequency	50 Hz / 60 Hz
Rated output current	13.6 A / 13 A
THDv (@linear load)	<3%
<b>Input AC (Grid side)</b>	
Input voltage range	184-264 V
Max. input current	23 A
Frequency range	45-55 Hz / 55-65 Hz
<b>Efficiency</b>	
Max. battery charge efficiency	94.0%
Max. battery discharge efficiency	94.5%
<b>Protection</b>	
Battery reverse protection	Yes
Battery over and under voltage protection	Yes
Short circuit protection	Yes
Output over current protection	Yes
Temperature protection	Yes
<b>General Data</b>	
Dimensions (W*H*D)	405*510*150 mm
Weight	12.1 kg
Topology	High frequency isolation
Operating ambient temperature range	-25 ~ +60°C
Ingress protection	IP65
Cooling concept	Natural convection
Max. operation altitude	2000 m
Grid connection standard	G98 or G99, VDE-AR-N 4105/VDE V 0124, EN 50549-1, VDE 0126/UTE C 15/VFR:2019, RD 1699/RD 244/UNE 206006/UNE 206007-1, CEI 0-21, C10/11, NRS 097-2-1, EIFS 2018.2, IEC 62116, IEC 61727, IEC 60068, IEC 61683, MEA, PEA
Safety/EMC standard	IEC 62477, EN 61000-6-2/-3
<b>Features</b>	
DC connection	Screw terminal
AC connection	Screw clamp terminal (max. 6 mm <sup>2</sup> )
Display	LCD
Communication	RS485, CAN, Optional: Wi-Fi, GPRS

# Off-grid Energy Storage Solutions



Solis EO series inverter is designed for residential off-grid systems in the countries without stable grid power, which can work with batteries to supply power to load and can also charge the batteries through PV plants, grid or generator.

The product has a variety of application scenarios combination modes, and can realize modular system assembly configuration according to needs. And can provide multiple products in parallel to form up to 50kW three-phase or single-phase parallel operation system, which is very suitable for small industrial, commercial or residential energy storage projects.

## Off-grid Energy Storage Solution - Single EO Inverter

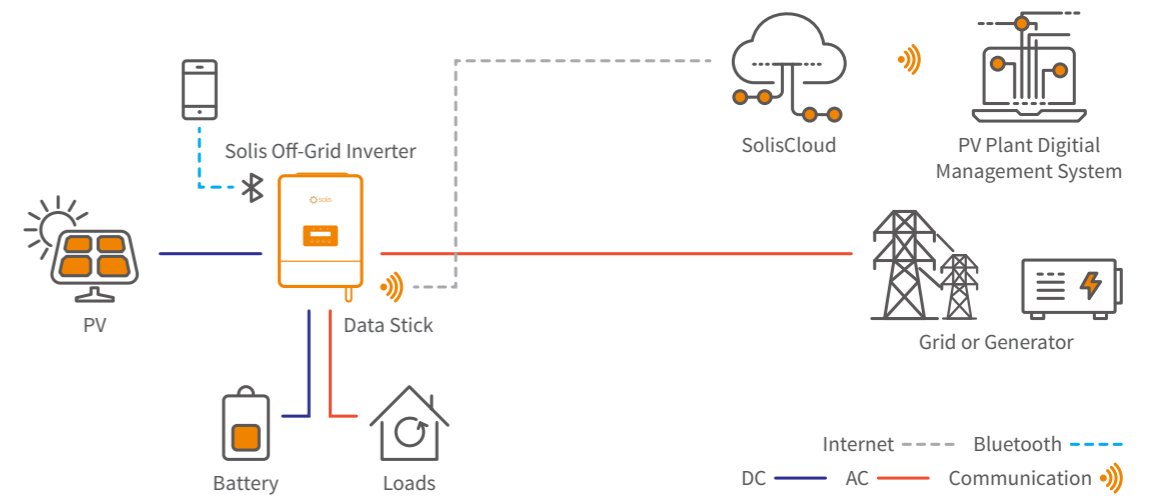

## Off-grid Energy Storage Solution - Multiple Parallel EO Inverters

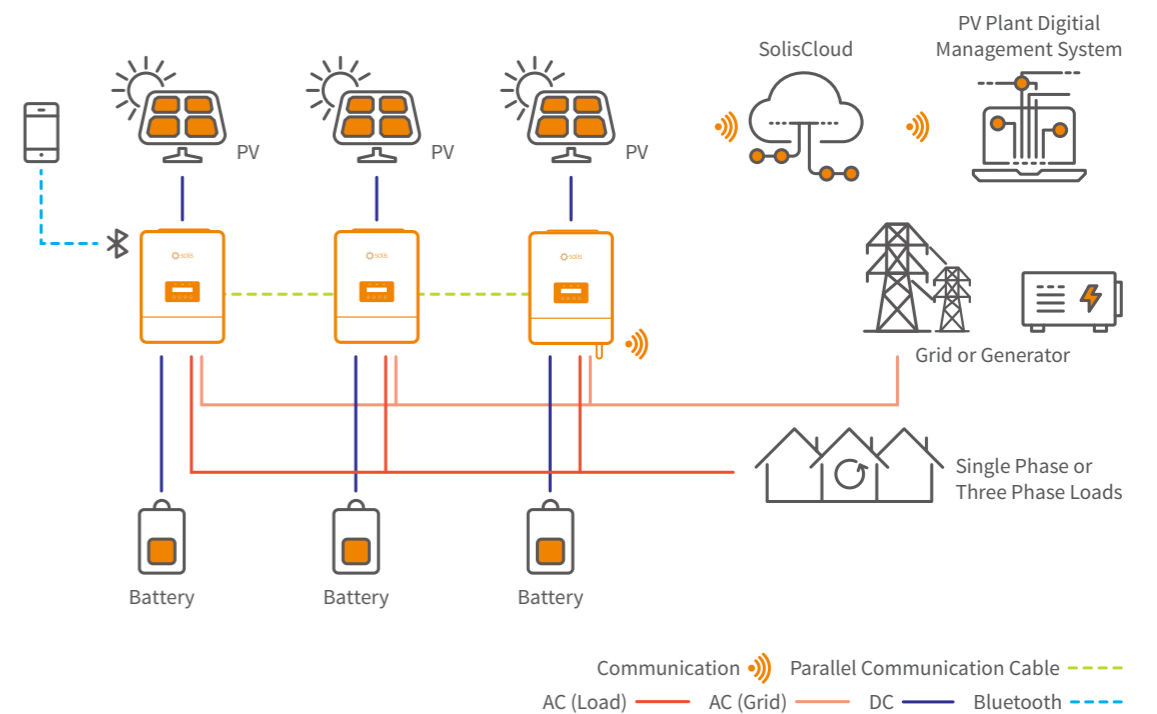

## S5-E01P(4-5)K-48

### Solis Energy Storage Inverters

#### Flexible Communications

- Integrated LCD display
- Built-in bluetooth communication
- Remote control & firmware upgrade

#### Adaptive

- Configurable AC/solar input priority based on applications
- Single phase parallel operation up to 10 units (50kW)
- Intelligent EMS function

#### High Performance

- 80 Amp AC charger and 100 Amp solar charger
- Maximum PV input voltage up to 500VDC
- Built-in MPPT solar charge controller

#### Battery Friendly

- Compatible with all top-tier brands of lithium batteries and lead-acid batteries
- Battery equalization for increased battery performance and lifespan
- Functional with or without a battery
- One-click fast charging mode
- Manual wakeup the overdischarged battery to extend battery lifespan

#### Models:

S5-E01P4K-48 / S5-E01P4K-48-P

S5-E01P5K-48 / S5-E01P5K-48-P



360° View



## DATASHEET

## S5-E01P(4-5)K-48

Models	4K	4K-P	5K	5K-P
Parallel capability	No	Yes, 10 units	No	Yes, 10 units
<b>Battery</b>				
Rated battery voltage	48 V			
Battery type	Li-ion / Lead-acid			
Max. charge / discharge current	100 A			
Communication	CAN/RS485			
<b>Inverter Output</b>				
Rated output power	4 kVA / 4 kW		5 kVA / 5 kW	
Rated output voltage	230 V ± 1%			
Rated frequency	50 Hz / 60 Hz ± 0.1%			
Surge capacity	8 kVA		10 kVA	
Output voltage waveform	Pure sine wave			
Transfer time	10 ms typical, 20 ms Max			
THDv (@linear load)	<3%			
Peak efficiency (PV-AC)	96.7%			
<b>Solar Charger</b>				
Solar charger type	MPPT			
Recommended max. PV power	5 kW		5.5 kW	
Max. input voltage	500 V			
MPPT voltage range	90-480 V			
MPPT number/Max. input strings number	1/2			
Max. input current per MPPT	26 A <sup>(1)</sup>			
Max. solar charge current	100 A			
<b>AC Charger</b>				
Rated input voltage	230 V			
Selectable voltage range	90-280 V			
AC frequency range	50 Hz / 60 Hz (Auto sensing)			
Max. AC charge current	60 A		80 A	
<b>Protection</b>				
Output over voltage protection	Yes			
Output over current protection	Yes			
Short circuit protection	Yes			
Surge protection	Yes			
Temperature protection	Yes			
Integrated AFCI (DC arc-fault circuit protection)	Yes			
<b>General Data</b>				
Dimensions (W*H*D)	335*450*160 mm			
Weight	14 kg			
Relative humidity	5% to 95% (Non-condensing)			
Operating ambient temperature range	-10 ~ +60°C			
Storage temperature range	-25 ~ +60°C			
Ingress protection	IP21			
Max. operation altitude	2000 m			
Safety standard	IEC 62109, IEC 61000			
<b>Features</b>				
DC connection	Terminal connectors			
AC connection	Terminal connectors			
Display	LCD			
Communication	CAN, BMS, RS485, Dry-contact, Bluetooth, Optional: Wi-Fi			

(1) Max. input current per string will be 26A for one string's design and 13A for two strings' design;  
Max. input short current per string will be 32A for one string's design and 16A for two strings' design.

# Commercial & Industrial Solar PV Solutions

Solis industrial and commercial string inverter product line is rich, the power range covers 25kW - 110kW, no matter how large your design and requirements are, we can rely on our flexible products to provide you with the best industry green power solutions.

Solis provides the most extensive industrial and commercial string inverter products on the market, and the products are sold well in various countries and regions in the world. They perform well in various harsh and complex environments, and are very stable and reliable.

Solis' C&I products are compatible with modularity and flexibility in program design. From the perspective of inverter performance improvement, we provide an ideal solution for simplifying system planning and design. Including optimizing software algorithms, optimizing hardware port compatibility, etc., to improve system efficiency and reduce system investment costs.

The power range of Solis' C&I products covers a wide range, with a single power up to 110kW. High-efficiency and high-power-density inverters can reduce installation and maintenance workloads and improve overall cost efficiency.

Solis' C&I solutions are supplemented by a series of advanced digital services based on SolisCloud, simplifying the application difficulty of intelligent systems, and providing you with more complete, high-quality and efficient cloud intelligent operation and maintenance solutions.

**Models:** S5-GC(25-40)K / S5-GC(50-60)K

Solis-80K-5G / S5-GC80K

Solis-(80-110)K-5G-PRO / Solis-(100-110)K-5G

S5-GC(100-110)K

**Output:** 25kW ~ 110kW

## Commercial & Industrial Solar PV Solution

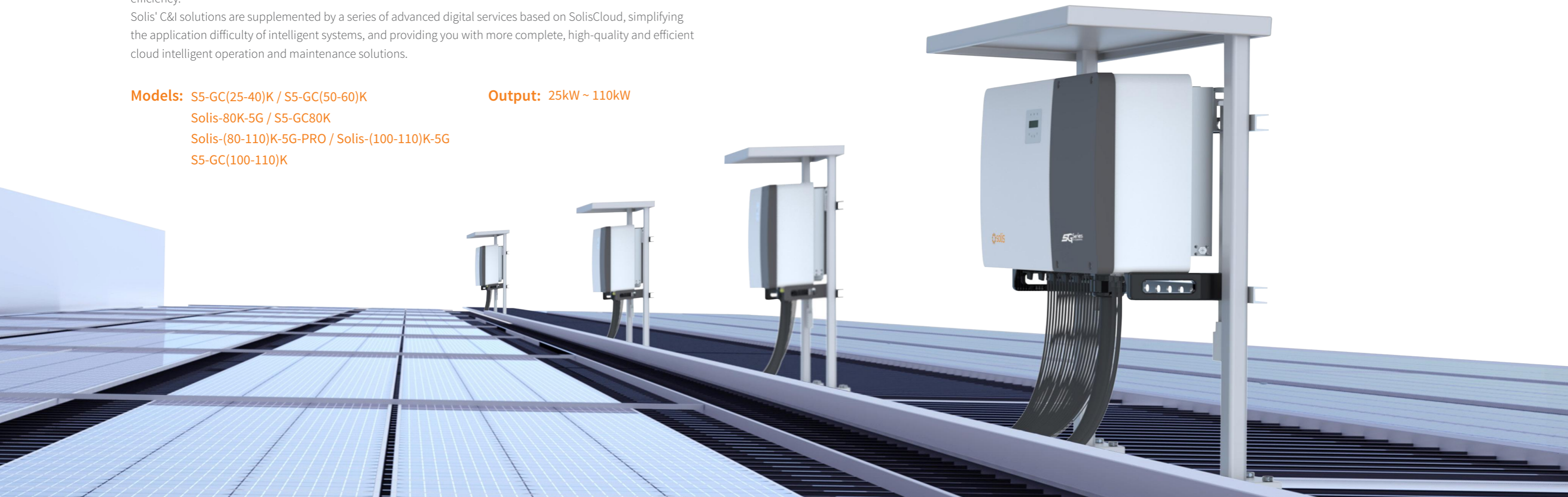
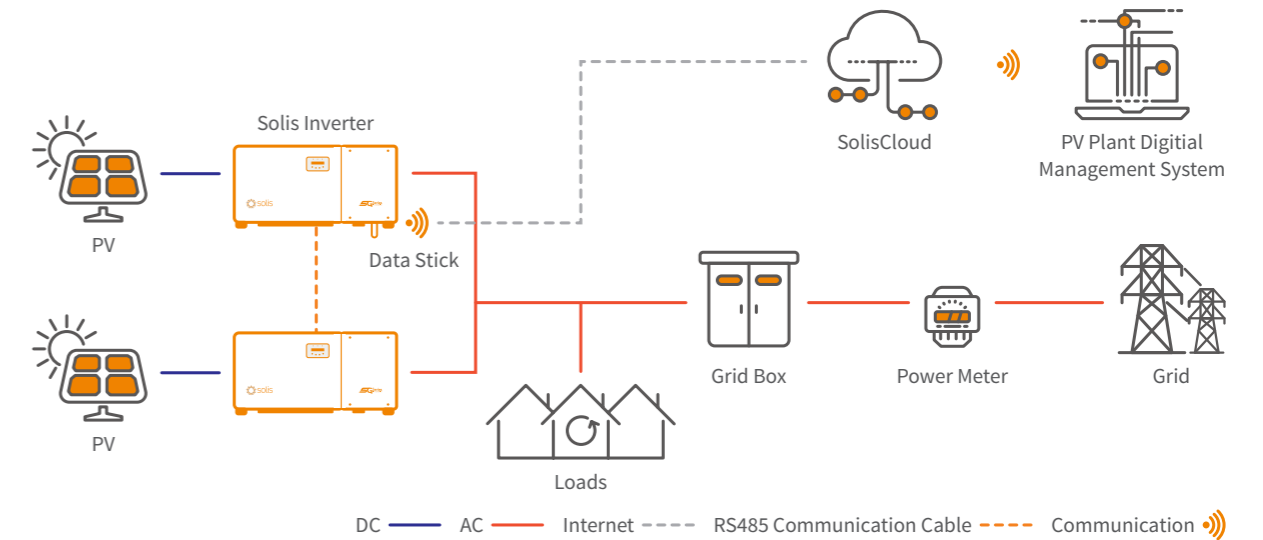

**S5-GC(25-40)K****Solis Three Phase Inverters****Efficient**

- Max. efficiency 98.7%
- String current up to 16A
- 3/4 MPPT design, supports multiple orientation system design
- Night time PID recovery function, increases overall system yield (optional)
- Wide voltage range and low startup voltage

**Smart**

- Supports export power control
- Intelligent string monitoring, smart I-V curve scan
- Supports RS485, WiFi, GPRS
- Scan to register on SolisCloud, supports remote upgrade and control

**Safe**

- IP66
- AFCI protection, proactively reduces fire risk
- Globally recognised branded componentry for longer life
- Intelligent redundant fan-cooling

**Economic**

- Supports GPRS/WiFi communication with less wiring and reduced installation costs
- > 150% DC/AC ratio
- Supports high power modules for lower installation costs
- Supports aluminium wire access to reduce cost

**Models:**

S5-GC25K / S5-GC30K

S5-GC33K / S5-GC36K

S5-GC40K



360° View

**DATASHEET****S5-GC(25-40)K**

Models	25K	30K	33K	36K	40K
<b>Input DC</b>					
Recommended max. PV power	37.5 kW	45 kW	49.5 kW	54 kW	60 kW
Max. input voltage	1100 V				
Rated voltage	600 V				
Start-up voltage	180 V				
MPPT voltage range	200-1000 V				
Max. input current	32 A / 32 A / 32 A			4*32 A	
Max. short circuit current	40 A / 40 A / 40 A			4*40 A	
MPPT number/Max. input strings number	3/6			4/8	
<b>Output AC</b>					
Rated output power	25 kW	30 kW	33 kW	36 kW	40 kW
Max. apparent output power	27.5 kVA	33 kVA	36.3 kVA	39.6 kVA	44 kVA
Max. output power	27.5 kW	33 kW	36.3 kW	39.6 kW	44 kW
Rated grid voltage	3/N/PE, 220 V / 380 V, 230 V / 400 V				
Rated grid frequency	50 Hz / 60 Hz				
Rated grid output current	38.0 A / 36.1 A	45.6 A / 43.3 A	50.1 A / 47.6 A	54.7 A / 52.0 A	60.8 A / 57.7 A
Max. output current	41.8 A	50.2 A	55.1 A	60.2 A	66.9 A
Power factor	>0.99 (0.8 leading - 0.8 lagging)				
THDi	<3%				
<b>Efficiency</b>					
Max. efficiency	98.5%		98.6%		98.7%
EU efficiency	98.1%		98.2%		98.3%
<b>Protection</b>					
DC reverse-polarity protection	Yes				
Short circuit protection	Yes				
Output over current protection	Yes				
Surge protection	DC Type II / AC Type II				
Grid monitoring	Yes				
Anti-islanding protection	Yes				
Temperature protection	Yes				
Strings monitoring	Yes				
I/V Curve scanning	Yes				
Integrated AFCI (DC arc-fault circuit protection)	Yes <sup>(1)</sup>				
Integrated PID recovery	Optional				
Integrated DC switch	Optional				
<b>General Data</b>					
Dimensions (W*H*D)	647*629*252 mm				
Weight	37 kg				
Topology	Transformerless				
Self-consumption (night)	<1 W				
Operating ambient temperature range	-25 ~ +60°C				
Relative humidity	0-100%				
Ingress protection	IP66				
Cooling concept	Intelligent redundant fan-cooling				
Max. operation altitude	4000 m				
Grid connection standard	G99, VDE-AR-N 4105 / VDE V 0124, EN 50549-1, VDE 0126 / UTE C 15 / VFR:2019, RD 1699 / RD 244 / UNE 206006 / UNE 206007-1, CEI 0-21, C10/11, NRS 097-2-1, EIFS 2018.2, IEC 62116, IEC 61727, IEC60068, IEC 61683, EN 50530				
Safety/EMC standard	IEC/EN 62109-1/-2, IEC/EN 61000-6-1/-2/-3/-4				
<b>Features</b>					
DC connection	MC4 connector				
AC connection	OT terminal				
Display	LCD				
Communication	RS485, Optional: Wi-Fi, GPRS				

(1) Activation required.



## S5-GC(50-60)K

### Solis Three Phase Inverters

#### Efficient

- Max. efficiency 98.7%
- String current up to 16A
- 5/6 MPPT design, supports multiple orientation system design
- Night time PID recovery function, increases overall system yield (optional)

#### Smart

- Night SVG function
- Supports export power control
- Intelligent string monitoring, smart I-V curve scan
- Scan to register on SolisCloud, supports remote upgrade and control

#### Safe

- IP66, C5 Anti-Corrosion Level
- Intelligent redundant fan-cooling
- Globally recognised branded componentry for longer life
- AFCI protection, proactively reduces fire risk

#### Economic

- Supports GPRS/WiFi communication with less wiring and reduced installation costs
- DC side supports "Y" connector
- Supports aluminium wire access to reduce cost
- 10/12 string inputs allow for 150%+ DC oversizing

#### Models:

S5-GC50K / S5-GC60K



360° View

## DATASHEET

## S5-GC(50-60)K

Models	50K	60K
<b>Input DC</b>		
Max. input voltage	1100 V	
Rated voltage	600 V	
Start-up voltage	195 V	
MPPT voltage range	180-1000 V	
Max. input current	5*32 A	6*32 A
Max. short circuit current	5*40 A	6*40 A
MPPT number/Max. input strings number	5/10	6/12
<b>Output AC</b>		
Rated output power	50 kW	60 kW
Max. apparent output power	55 kVA	66 kVA
Max. output power	55 kW	66 kW
Rated grid voltage	3/N/PE, 220 V / 380 V, 230 V / 400 V	
Rated grid frequency	50 Hz / 60 Hz	
Rated grid output current	76.0 A / 72.2 A	91.2 A / 86.6 A
Max. output current	83.6 A	100.3 A
Power factor	>0.99 (0.8 leading - 0.8 lagging)	
THDi	<3%	
<b>Efficiency</b>		
Max. efficiency	98.7%	
EU efficiency	98.3%	
<b>Protection</b>		
DC reverse-polarity protection	Yes	
Short circuit protection	Yes	
Output over current protection	Yes	
Surge protection	DC Type II / AC Type II	
Grid monitoring	Yes	
Anti-islanding protection	Yes	
Temperature protection	Yes	
Strings monitoring	Yes	
I/V Curve scanning	Yes	
Integrated AFCI (DC arc-fault circuit protection)	Yes <sup>(1)</sup>	
Integrated PID recovery	Optional <sup>(2)</sup>	
Integrated DC switch	Optional	
<b>General Data</b>		
Dimensions (W*H*D)	691*578*338 mm	
Weight	54.5 kg	
Topology	Transformerless	
Self-consumption (night)	<1 W	
Operating ambient temperature range	-25 ~ +60°C	
Relative humidity	0-100%	
Ingress protection	IP66	
Cooling concept	Intelligent redundant fan-cooling	
Max. operation altitude	4000 m	
Grid connection standard	G99, VDE-AR-N 4105 / VDE V 0124, EN 50549-1, VDE 0126 / UTE C 15 / VFR:2019, RD 1699 / RD 244 / UNE 206006 / UNE 206007-1, CEI 0-21, C10/11, NRS 097-2-1, EIFS 2018.2, IEC 62116, IEC 61727, IEC60068, IEC 61683, EN 50530	
Safety/EMC standard	IEC 62109-1/-2, IEC62116 & IEC 61000-6-1/-2/-3/-4	
<b>Features</b>		
DC connection	MC4 connector	
AC connection	OT terminal (max. 70 mm <sup>2</sup> )	
Display	LCD, Capacitive touch buttons	
Communication	RS485, USB, Optional: Wi-Fi, GPRS	

(1) Activation required. (2) Due to the similar functional logic, when the night time PID-Recovery function is integrated, the night time var compensation function can not be used. Also, the negative grounding option is not available for inverters with night time PID-Recovery function.

## Solis-80K-5G

### Solis Three Phase Inverters

#### Efficient

- 9 MPPTs, max. efficiency 98.7%
- > 150% DC/AC ratio
- Compatible with bifacial modules

#### Smart

- Night SVG function
- Intelligent string monitoring, smart I-V curve scan
- Remote firmware upgrade with simple operation

#### Safe

- IP66
- Built-in PID recovery for better module performance (optional)
- AFCI protection, proactively reduces fire risk
- Globally recognised branded componentry for longer life

#### Economic

- Power line communication (PLC) (optional)
- DC side supports "Y" connector
- Supports aluminium wire access to reduce cost

#### Models:

Solis-80K-5G



360° View

## DATASHEET

## Solis-80K-5G

Models	80K
<b>Input DC</b>	
Max. input voltage	1100 V
Rated voltage	600 V
Start-up voltage	195 V
MPPT voltage range	180-1000 V
Max. input current	9*26 A
Max. short circuit current	9*40 A
MPPT number/Max. input strings number	9/18
<b>Output AC</b>	
Rated output power	80 kW
Max. apparent output power	88 kVA
Max. output power	88 kW
Rated grid voltage	3/N/PE, 220 V / 380 V, 230 V / 400 V
Rated grid frequency	50 Hz / 60 Hz
Rated grid output current	121.6 A / 115.5 A
Max. output current	133.7 A
Power factor	>0.99 (0.8 leading - 0.8 lagging)
THDi	<3%
<b>Efficiency</b>	
Max. efficiency	98.7%
EU efficiency	98.3%
<b>Protection</b>	
DC reverse-polarity protection	Yes
Short circuit protection	Yes
Output over current protection	Yes
Surge protection	DC Type II / AC Type II
Grid monitoring	Yes
Anti-islanding protection	Yes
Temperature protection	Yes
Strings monitoring	Yes
I/V Curve scanning	Yes
Integrated AFCI (DC arc-fault circuit protection)	Yes <sup>(1)</sup>
Integrated PID recovery	Optional
Integrated DC switch	Yes
Integrated AC switch	Optional
<b>General Data</b>	
Dimensions (W*H*D)	1050*567*314.5 mm (with AC switch)
Weight	82 kg
Topology	Transformerless
Self-consumption (night)	<2 W
Operating ambient temperature range	-30 ~ +60°C
Relative humidity	0-100%
Ingress protection	IP66
Cooling concept	Intelligent redundant fan-cooling
Max. operation altitude	4000 m
Grid connection standard	G98 or G99, VDE-AR-N 4105 / VDE-AR-N 4110 / VDE V 0124, EN 50549-1, VDE 0126 / UTE C 15 / VFR:2019, CEI 0-21, C10/11, NRS 097-2-1, TOR, EIFS 2018.2, IEC 62116, IEC 61727, IEC 60068, IEC 61683, EN 50530
Safety/EMC standard	IEC/EN 62109-1/-2, IEC/EN 61000-6-2/-4
<b>Features</b>	
DC connection	MC4 connector
AC connection	OT terminal (max. 185 mm <sup>2</sup> )
Display	LCD
Communication	RS485, Optional: Wi-Fi, GPRS, PLC

(1) Activation required.

**S5-GC80K****Solis Three Phase Inverters****Efficient**

- 9 MPPTs, max. efficiency 98.7%
- > 150% DC/AC ratio
- String current up to 16A, perfectly match large current bifacial modules

**Smart**

- Night SVG function
- Intelligent string monitoring, smart I-V curve scan
- Remote firmware upgrade with simple operation

**Safe**

- IP66
- Built-in PID recovery for better module performance (optional)
- AFCI protection, proactively reduces fire risk
- Globally recognised branded componentry for longer life

**Economic**

- Power line communication (PLC) (optional)
- DC side supports "Y" connector
- Supports aluminium wire access to reduce cost

**Models:**

S5-GC80K



360° View

**DATASHEET****S5-GC80K**

Models	80K
<b>Input DC</b>	
Max. input voltage	1100 V
Rated voltage	600 V
Start-up voltage	195 V
MPPT voltage range	180-1000 V
Max. input current	9*32 A
Max. short circuit current	9*40 A
MPPT number/Max. input strings number	9/18
<b>Output AC</b>	
Rated output power	80 kW
Max. apparent output power	88 kVA
Max. output power	88 kW
Rated grid voltage	3/N/PE, 220 V / 380 V, 230 V / 400 V
Rated grid frequency	50 Hz / 60 Hz
Rated grid output current	121.6 A / 115.5 A
Max. output current	133.7 A
Power factor	>0.99 (0.8 leading - 0.8 lagging)
THDi	<3%
<b>Efficiency</b>	
Max. efficiency	98.7%
EU efficiency	98.3%
<b>Protection</b>	
DC reverse-polarity protection	Yes
Short circuit protection	Yes
Output over current protection	Yes
Surge protection	DC Type II / AC Type II
Grid monitoring	Yes
Anti-islanding protection	Yes
Temperature protection	Yes
Strings monitoring	Yes
I/V Curve scanning	Yes
Integrated AFCI (DC arc-fault circuit protection)	Yes <sup>(1)</sup>
Integrated PID recovery	Optional
Integrated DC switch	Yes
Integrated AC switch	Optional
<b>General Data</b>	
Dimensions (W*H*D)	1050*567*314.5 mm (with AC switch)
Weight	85 kg
Topology	Transformerless
Self-consumption (night)	<2 W
Operating ambient temperature range	-30 ~ +60°C
Relative humidity	0-100%
Ingress protection	IP66
Cooling concept	Intelligent redundant fan-cooling
Max. operation altitude	4000 m
Grid connection standard	G98 or G99, VDE-AR-N 4105 / VDE-AR-N 4110 / VDE V 0124, EN 50549-1, VDE 0126 / UTE C 15 / VFR:2019, CEI 0-21, C10/11, NRS 097-2-1, TOR, EIFS 2018.2, IEC 62116, IEC 61727, IEC 60068, IEC 61683, EN 50530
Safety/EMC standard	IEC/EN 62109-1/-2, IEC/EN 61000-6-2/-4
<b>Features</b>	
DC connection	MC4 connector
AC connection	OT terminal (max. 185 mm <sup>2</sup> )
Display	LCD
Communication	RS485, Optional: Wi-Fi, GPRS, PLC

(1) Activation required.

## Solis-(80-110)K-5G-PRO

### Solis Three Phase Inverters

#### Efficient

- 6/8 MPPTs, max. efficiency 98.5%
- > 150% DC/AC ratio
- Compatible with bifacial modules

#### Smart

- Night SVG function
- Intelligent string monitoring, smart I-V curve scan
- Remote firmware upgrade with simple operation

#### Safe

- IP66
- AFCI protection, proactively reduces fire risk
- Globally recognised branded componentry for longer life

#### Economic

- Power line communication (PLC) (optional)
- DC side supports "Y" connector
- Supports aluminium wire access to reduce cost

#### Models:

Solis-80K-5G-PRO

Solis-100K-5G-PRO

Solis-110K-5G-PRO



## DATASHEET

### Solis-(80-110)K-5G-PRO

Models	80K	100K	110K
<b>Input DC</b>			
Max. input voltage	1100 V		
Rated voltage	600 V		
Start-up voltage	180 V		
MPPT voltage range	160-1000 V		
Max. input current	36 A / 32 A / 36 A / 32 A / 36 A / 32 A	36 A / 32 A / 36 A / 32 A / 36 A / 32 A / 36 A / 32 A	
Max. short circuit current	6*50 A	8*50 A	
MPPT number/Max. input strings number	6/12	8/16	
<b>Output AC</b>			
Rated output power	80 kW	100 kW	110 kW
Max. apparent output power	88 kVA	110 kVA	121 kVA
Max. output power	88 kW	110 kW	121 kW
Rated grid voltage	3/N/PE, 220 V / 380 V, 230 V / 400 V		
Rated grid frequency	50 Hz / 60 Hz		
Rated grid output current	121.6 A / 115.5 A	152.0 A / 144.3 A	167.1 A / 158.8 A
Max. output current	133.7 A	167.1 A	183.8 A
Power factor	>0.99 (0.8 leading - 0.8 lagging)		
THDi	<3%		
<b>Efficiency</b>			
Max. efficiency	98.5%		
EU efficiency	98%		
<b>Protection</b>			
DC reverse-polarity protection	Yes		
Short circuit protection	Yes		
Output over current protection	Yes		
Surge protection	DC Type II / AC Type II		
Grid monitoring	Yes		
Anti-islanding protection	Yes		
Temperature protection	Yes		
Strings monitoring	Yes		
I/V Curve scanning	Yes		
Integrated AFCI (DC arc-fault circuit protection)	Yes <sup>(1)</sup>		
Integrated DC switch	Yes		
<b>General Data</b>			
Dimensions (W*H*D)	1183*585*363 mm		
Weight	77 kg	93 kg	
Topology	Transformerless		
Self-consumption (night)	<2 W		
Operating ambient temperature range	-30 ~ +60°C		
Relative humidity	0-100%		
Ingress protection	IP66		
Cooling concept	Intelligent redundant fan-cooling		
Max. operation altitude	4000 m		
Grid connection standard	G99, IEC61727, EN50549-1/2, VDE4110		
Safety/EMC standard	IEC/EN 62109-1/-2, IEC/EN 61000-6-2/-4		
<b>Features</b>			
DC connection	MC4 connector		
AC connection	OT terminal (max. 240 mm <sup>2</sup> )		
Display	LCD		
Communication	RS485, Optional: Wi-Fi, GPRS, PLC		

(1) Activation required.

## Solis-(100-110)K-5G

### Solis Three Phase Inverters

#### Efficient

- 10 MPPTs, max. efficiency 98.7%
- > 150% DC/AC ratio
- High power tracking density 90MPPT/MW
- Compatible with bifacial modules

#### Smart

- Night SVG function
- Intelligent string monitoring, smart I-V curve scan
- Remote firmware upgrade with simple operation

#### Safe

- AFCI protection, proactively reduces fire risk
- Built-in PID recovery for better module performance (optional)
- Type I SPD for AC (optional)
- Overvoltage load reduction and leakage current suppression technology, low failure rate
- Globally recognised branded componentry for longer life

#### Economic

- Power line communication (PLC) (optional)
- DC side supports "Y" connector
- Supports aluminium wire access to reduce cost

#### Models:

Solis-100K-5G

Solis-110K-5G



360° View

## DATASHEET

### Solis-(100-110)K-5G

Models	100K	110K
<b>Input DC</b>		
Max. input voltage	1100 V	
Rated voltage	600 V	
Start-up voltage	195 V	
MPPT voltage range	180-1000 V	
Max. input current	10*26 A	
Max. short circuit current	10*40 A	
MPPT number/Max. input strings number	10/20	
<b>Output AC</b>		
Rated output power	100 kW	110 kW
Max. apparent output power	110 kVA	121 kVA
Max. output power	110 kW	121 kW
Rated grid voltage	3/N/PE, 220 V / 380 V, 230 V / 400 V	
Rated grid frequency	50 Hz / 60 Hz	
Rated grid output current	152.0 A / 144.3 A	167.1 A / 158.8 A
Max. output current	167.1 A	183.8 A
Power factor	>0.99 (0.8 leading - 0.8 lagging)	
THDi	<3%	
<b>Efficiency</b>		
Max. efficiency	98.7%	
EU efficiency	98.3%	
<b>Protection</b>		
DC reverse-polarity protection	Yes	
Short circuit protection	Yes	
Output over current protection	Yes	
Surge protection	DC Type II / AC Type II (AC Type I optional)	
Grid monitoring	Yes	
Anti-islanding protection	Yes	
Temperature protection	Yes	
Strings monitoring	Yes	
I/V Curve scanning	Yes	
Integrated AFCI (DC arc-fault circuit protection)	Yes <sup>(1)</sup>	
Integrated PID recovery	Optional	
Integrated DC switch	Yes	
Integrated AC switch	Optional	
<b>General Data</b>		
Dimensions (W*H*D)	1065*567*344.5 mm	
Weight	91 kg	
Topology	Transformerless	
Self-consumption (night)	<2 W	
Operating ambient temperature range	-30 ~ +60°C	
Relative humidity	0-100%	
Ingress protection	IP66	
Cooling concept	Intelligent redundant fan-cooling	
Max. operation altitude	4000 m	
Grid connection standard	VDE-AR-N 4105, VDE-AR-N 4110, VDE V 0124, VDE V 0126-1-1, UTE C15-712-1, NRS 097-1-2, G98, G99, EN 50549-1/-2, RD 1699, TOR, UNE 206006, UNE 206007-1, CEI 0-21, IEC61727, DEWA	
Safety/EMC standard	IEC/EN 62109-1/-2, IEC/EN 61000-6-2/-4	
<b>Features</b>		
DC connection	MC4 connector	
AC connection	OT terminal (max. 185 mm <sup>2</sup> )	
Display	LCD	
Communication	RS485, Optional: Wi-Fi, GPRS, PLC	

(1) Activation required.

## S5-GC(100-110)K

### Solis Three Phase Inverters

#### Efficient

- 10 MPPTs, max. efficiency 98.7%
- > 150% DC/AC ratio
- High power tracking density 90MPPT/MW
- String current up to 16A, perfectly match large current bifacial modules

#### Smart

- Night SVG function
- Intelligent string monitoring, smart I-V curve scan
- Remote firmware upgrade with simple operation

#### Safe

- AFCI protection, proactively reduces fire risk
- Built-in PID recovery for better module performance (optional)
- Type I SPD for AC (optional)
- Overvoltage load reduction and leakage current suppression technology, low failure rate
- Globally recognised branded componentry for longer life

#### Economic

- Power line communication (PLC) (optional)
- DC side supports "Y" connector
- Supports aluminium wire access to reduce cost

#### Models:

S5-GC100K

S5-GC110K



## DATASHEET

## S5-GC(100-110)K

Models	100K	110K
<b>Input DC</b>		
Max. input voltage	1100 V	
Rated voltage	600 V	
Start-up voltage	195 V	
MPPT voltage range	180-1000 V	
Max. input current	10*32 A	
Max. short circuit current	10*40 A	
MPPT number/Max. input strings number	10/20	
<b>Output AC</b>		
Rated output power	100 kW	110 kW
Max. apparent output power	110 kVA	121 kVA
Max. output power	110 kW	121 kW
Rated grid voltage	3/N/PE, 220 V / 380 V, 230 V / 400 V	
Rated grid frequency	50 Hz / 60 Hz	
Rated grid output current	152.0 A / 144.3 A	167.1 A / 158.8 A
Max. output current	167.1 A	183.8 A
Power factor	>0.99 (0.8 leading - 0.8 lagging)	
THDi	<3%	
<b>Efficiency</b>		
Max. efficiency	98.7%	
EU efficiency	98.3%	
<b>Protection</b>		
DC reverse-polarity protection	Yes	
Short circuit protection	Yes	
Output over current protection	Yes	
Surge protection	DC Type II / AC Type II (AC Type I optional)	
Grid monitoring	Yes	
Anti-islanding protection	Yes	
Temperature protection	Yes	
Strings monitoring	Yes	
I/V Curve scanning	Yes	
Integrated AFCI (DC arc-fault circuit protection)	Yes <sup>(1)</sup>	
Integrated PID recovery	Optional	
Integrated DC switch	Yes	
Integrated AC switch	Optional	
<b>General Data</b>		
Dimensions (W*H*D)	1065*567*344.5 mm	
Weight	91 kg	
Topology	Transformerless	
Self-consumption (night)	<2 W	
Operating ambient temperature range	-30 ~ +60°C	
Relative humidity	0-100%	
Ingress protection	IP66	
Cooling concept	Intelligent redundant fan-cooling	
Max. operation altitude	4000 m	
Grid connection standard	VDE-AR-N 4105, VDE-AR-N 4110, VDE V 0124, VDE V 0126-1-1, UTE C15-712-1, NRS 097-1-2, G98, G99, EN 50549-1/-2, RD 1699, TOR, UNE 206006, UNE 206007-1, CEI 0-21, IEC61727, DEWA	
Safety/EMC standard	IEC/EN 62109-1/-2, IEC/EN 61000-6-1/-2/-3/-4	
<b>Features</b>		
DC connection	MC4 connector	
AC connection	OT terminal (max. 185 mm <sup>2</sup> )	
Display	LCD	
Communication	RS485, Optional: Wi-Fi, GPRS, PLC	

(1) Activation required.

## C&I Power Plant Case Study



### Ninghai Power Plant

- China
- 38MW
- Solis-(215-255)K-EHV-5G

Ninghai Power Plant transitions away from traditional thermal power to integrate solar power generation overcoming technical challenges along the way.

Ninghai Power is dedicated to the innovation of greener power through science and technology and has become a leader in Agrisolar development. As a pioneer in its industry the company has implemented a new energy park project which includes fishery-solar system, Agrisolar and floating solar systems, solar carport and



solar corridor as well as a more traditional solar rooftop. Over 8 different installation types have enabled more green energy to be installed in more areas - true "out of the box" thinking.

The solar plant now generates more than 300 billion kilowatts of green energy.



- India
- 1.12MW
- S5-GC(80-110)K



- Greece
- 100kW
- S5-GC(100-110)K

- UK
- 2MW
- Solis-(100-110)K-5G



- Netherlands
- 168.35kW
- Solis-(80-110)K-5G



- Philippines
- 270kW
- Solis-(25-30)K-LV

# Utility Scale Solar PV Solutions



Solis has optimized and innovated around the entire process of utility solar PV solutions. Deeply integrated system design, digital management, and IoT technology effectively optimize the initial investment and future O&M costs of the power station increasing the power generation of the system and the rate of return on investment. Through the concept of "Efficient, safe, reliable, smart O&M, and system-friendly" we maximise the value for customers.

The 1500V high-power system solution can effectively reduce the number of equipment and cable consumption, reduce the initial investment cost, and facilitate installation and maintenance.

Solis utility PV solution has the characteristics of low LCOE. From the perspective of inverter performance improvement, it includes optimizing software algorithms and optimizing hardware port compatibility to improve system efficiency and reduce system investment costs.

Solis utility inverter has a large single power, up to 255kW. The high-efficiency and high-power-density inverter can reduce the workload of installation and maintenance, reduce costs and improve efficiency. Solis utility PV solution is supplemented by a series of advanced digital services and intelligent monitoring equipment based on SolisCloud, simplifying the application difficulty of the intelligent system, and providing a more complete, high-quality and efficient cloud smart O&M solution.

**Models:**

Solis-(215-255)K-EHV-5G

**Output:**

215 kW - 255 kW

Utility Scale Solar PV Solution

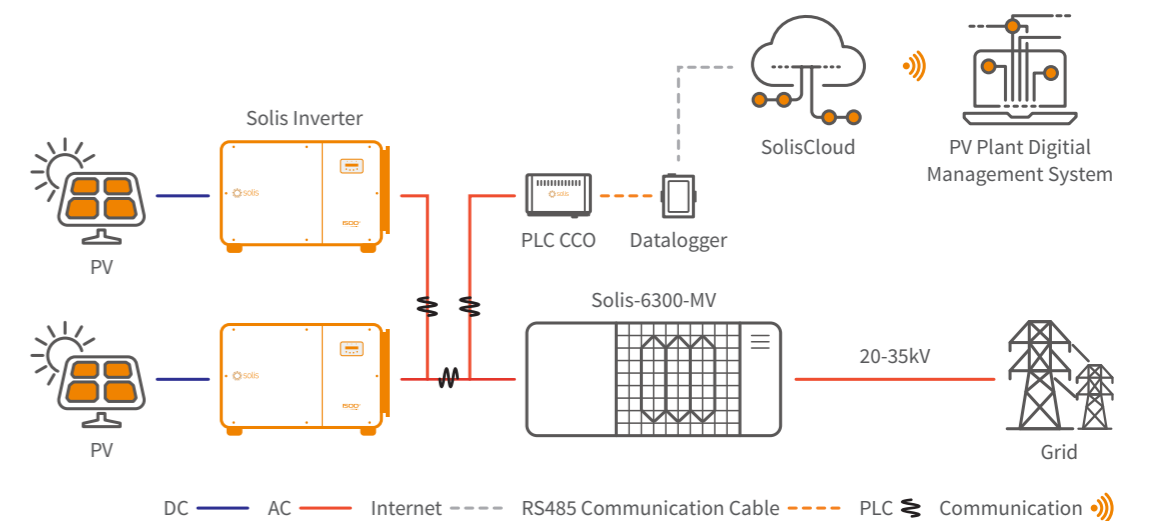



## Solis-(215-255)K-EHV-5G

### Solis Three Phase Inverters

#### Efficient

- 9/12/14 MPPTs, max. efficiency 99.0%
- > 150% DC/AC ratio
- High power tracking density 55MPPT/MW
- Compatible with 500W+ bifacial modules

#### Smart

- Night SVG function
- Intelligent string monitoring, smart I-V curve scan
- Remote firmware upgrade with simple operation

#### Safe

- IP66
- Built-in PID recovery for better module performance
- Fuse free design, safe and maintenance free
- Globally recognised branded componentry for longer life

#### Economic

- Power line communication (PLC) (optional)
- DC side supports "Y" connector
- Supports aluminium wire access to reduce cost

#### Models:

Solis-215K-EHV-5G-PLUS

Solis-255K-EHV-5G

Solis-255K-EHV-5G-PLUS



360° View

## DATASHEET

## Solis-(215-255)K-EHV-5G

Models	215K-PLUS	255K	255K-PLUS
<b>Input DC</b>			
Max. input voltage	1500 V		
Rated voltage	1080 V		
Start-up voltage	500 V		
MPPT voltage range	480-1500 V		
Max. input current	9*30 A	14*26 A	12*30 A
Max. short circuit current	9*50 A	14*40 A	12*50 A
MPPT number/Max. input strings number	9/18	14/28	12/24
<b>Output AC</b>			
Output power	215 kVA @ 30°C / 205 kVA @ 40°C / 195 kVA @ 50°C	255 kVA @ 30°C / 235 kVA @ 40°C / 220 kVA @ 50°C	
Rated grid voltage	3/PE, 800 V		
Grid voltage range	640-920 V		
Rated grid frequency	50 Hz / 60 Hz		
Max. output current	155.2 A	184.0 A	
Power factor	>0.99 (0.8 leading - 0.8 lagging)		
THDi	<3%		
<b>Efficiency</b>			
Max. efficiency	99.0%		
EU efficiency	98.8%	98.7%	98.8%
<b>Protection</b>			
DC reverse-polarity protection	Yes		
Short circuit protection	Yes		
Output over current protection	Yes		
Surge protection	DC Type II / AC Type II		
Grid monitoring	Yes		
Anti-islanding protection	Yes		
Temperature protection	Yes		
Strings monitoring	Yes		
I/V Curve scanning	Yes		
Night time SVG function	Yes		
Integrated PID recovery	Yes		
Integrated DC switch	Yes		
<b>General Data</b>			
Dimensions (W*H*D)	1125*770*384 mm		
Weight	109 kg	113 kg	
Topology	Transformerless		
Self-consumption (night)	<2 W		
Operating ambient temperature range	-30 ~ +60°C		
Relative humidity	0-100%		
Ingress protection	IP66		
Cooling concept	Intelligent redundant fan-cooling		
Max. operation altitude	4000 m		
Grid connection standard	EN50549, G99, AS4777.2, VDE0126, IEC61727, VDE4110, CEA 2019		
Safety/EMC standard	IEC/EN 62109-1/-2, IEC/EN 61000-6-2/-4		
<b>Features</b>			
DC connection	MC4 connector		
AC connection	OT terminal (max. 300 mm <sup>2</sup> )		
Display	LCD		
Communication	RS485, Optional: PLC		

## Solis-6300-MV

### Solis PV Station

For 1500 V string inverter Solis 255K

#### Integrated delivery

- Mainstream 6.3MW subarray,widely used global
- 20 foot standard container delivery, easy to transport

#### Convenient installation

- A complete solution, from inverter to main step-up transformer
- When the container is lifted to the foundation, only LV and MV cables need to be connected

#### Reliable products

- LV panel, transformer and RMU be placed independently
- Adopt international first-line brand equipment with reliable quality

#### Easy O&M

- Full frontal maintenance design
- Modular design of MV equipment, easy to replace



#### Circuit diagram

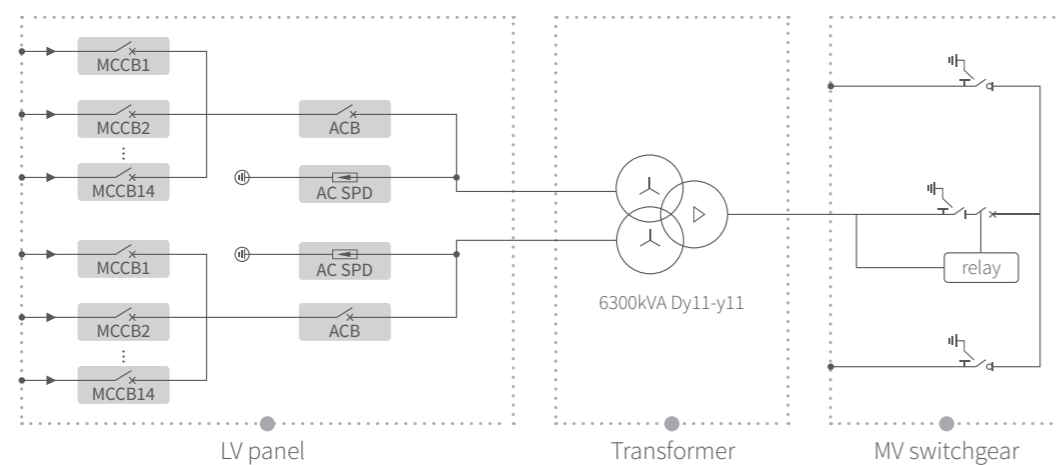

## DATASHEET

## Solis-6300-MV

Models	6300
<b>LV panel</b>	
MCCB specification	250 A / 800 Vac / 3P, 14*2 pcs
ACB specification	3200 A / 800 Vac / 3P, 1*2 pcs
Connection form with transformer	Copper busbar
<b>Transformer</b>	
Transformer type	Oil immersed
Rated output power	6300 kVA @ 40°C
Max. output power	6930 kVA @ 40°C 3h
LV/MV voltage	0.8 kV / 10-35 kV
Max. input current	2577 A *2
Tapping on HV	±2*2.5%
Vector group	Dy11y11
Frequency	50 Hz / 60 Hz
Cooling type	ONAN
Impedance	7%
Oil type	Mineral oil (Optional: plant oil)
Winding material	Al/Al (Optional: Cu/Cu)
Insulation class	A
Connection form with MV switchgear	Cable
<b>MV Switchgear</b>	
Type of insulate	SF6
Rated voltage	12-36 kV
Rated current	630 A
Internal arcing fault	20 kA / 1 s
Qty of feeder	3 feeders
<b>Protection</b>	
LV surge protection	AC type I+II
AC input protection	Circuit breaker
Transformer protection	Oil-temperature, oil-level, oil-pressure
Fire protection	Smoke detection, emergency lighting
<b>General Data</b>	
Dimensions (W*H*D)	6058*2896*2438 mm
Approximate weight	24 T
Operating temperature range	-25 ~ +60°C
Operating altitude	1000 m (standard)
Auxiliary power supply	5 kVA / 230 V (Optional: max. 40 kVA)
UPS	1 kVA 30 min (Optional: max. 2 kVA 2h)
Degree of protection	IP54
Allowable relative humidity range	0-95%
Communication	RS485, Ethernet, Optical fiber
Compliance	IEC 60076, IEC 62271, IEC61439

## Utility-scale Plant Case Study



India  
2MW Solis-(100-110)K



Poland  
10MW Solis-125K-EHV-5G



China  
300MW  
Solis-(215-255)K-EHV-5G



China  
1GW Solis-(215-255)K-EHV-5G



Mexico  
20MW Solis-20K-HV

### Tidal-Flat 300MW Utility Scale Solar PV Plant

After the project is put into operation, the generating capacity is estimated to be 400,000,000 kWh/ year and delivers a reduction of 350, 000 tons of CO<sub>2</sub>, 12,000 tons of SO<sub>2</sub>, and 110,000 tons of Carbon dust. Solis commercial scale string inverters boast an abundance of technological features which can adapt to a variety of environments. We look forward to seeing more applications utilizing Solis inverters. We are committed to our mission - Developing Technology to Power the World with Clean Energy.

# Export Power Management Solutions



In some countries, local regulations limit the amount of PV power that can be exported to the grid or allow no export. Solis offers two export limitation solutions for single and multiple inverters system.

## Export Power Management Solutions - Single-inverter System

In a single-inverter system, the export limitation is integrated into the inverter firmware. Use a meter or a CT to measure the output of the system, then to adjust PV power production.

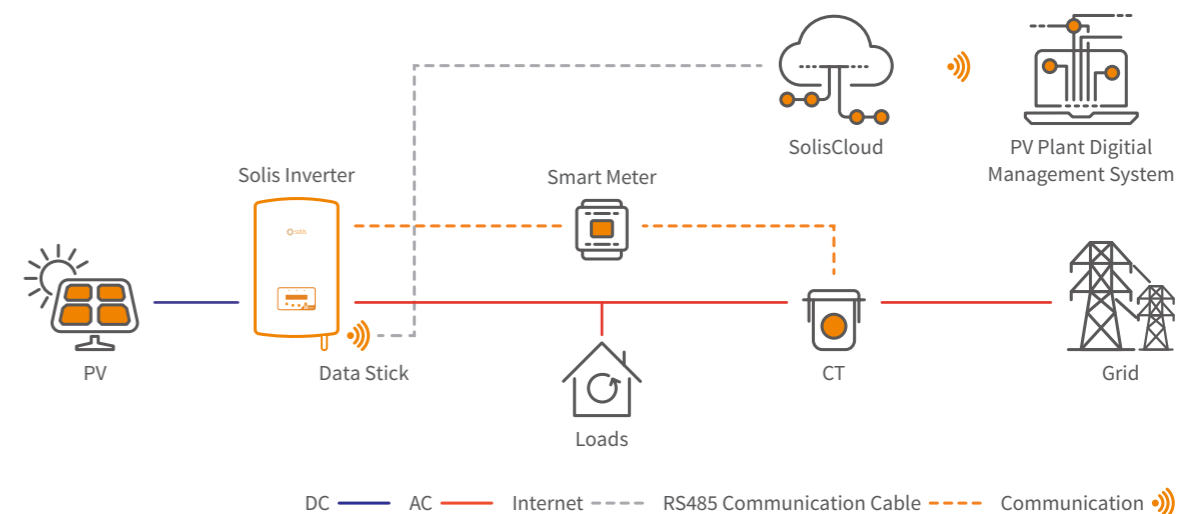

## Export Power Management Solution - Multi-inverter System

In a multi-inverter system, the export limitation is integrated into the EPM (Export Power Manager) firmware. The EPM will monitor and control the backflow power from the inverter to the grid thus providing export power control of inverters.

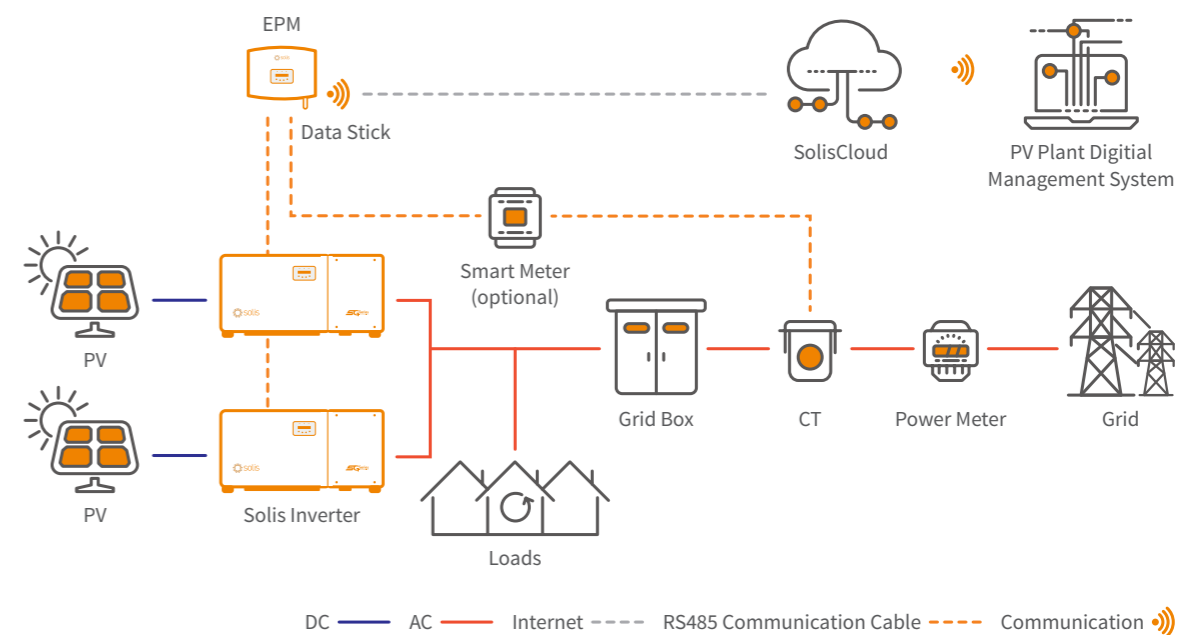

## Solis-EPM-5G

### Accessories - Solis Export Power Manager

#### Smart & strong

- Simultaneous control of 60 X Solis inverters
- Realizing reactive compensation of the system

#### Saving & high precision

- Simultaneously monitor the operating data of the 60 X Solis inverter, saving the cost of the monitoring system
- The control accuracy is up to 3%, which improves the system's spontaneous use rate

#### Friendly & compatible

- Supports simultaneous access of Solis inverters with different powers
- Monitor power generation and load consumption at all times

#### Models:

Solis-EPM1-5G

Solis-EPM3-5G

Solis-EPM3-5G-PRO



## DATASHEET

## Solis-EPM-5G

Models	Solis-EPM1-5G	Solis-EPM3-5G	Solis-EPM3-5G-PRO				
<b>Input AC</b>							
Rated voltage	1/N/PE, 230 V	3/N/PE, 230 V / 400 V					
Input voltage range	100 ~ 300 V (L-N)	175 ~ 520 V (L-L)					
Input frequency range	45~65 Hz						
<b>Communication</b>							
Inverter communication	Modbus						
Communication with inverter	RS485 (Wired)						
Max. communication inverter numbers	10	60 <sup>(1)</sup>					
Max. communication distance	1000 m						
Monitoring	WiFi/4G/LAN Stick (Optional)						
<b>General Data</b>							
Ambient temperature	-25 ~ +60°C						
Relative humidity	5%~95%						
Ingress protection	IP65						
Self-consumption	<5 W						
Dimensions (W*H*D)	364*276*114 mm						
Weight	2.1 kg (without CT, Meter)						
AC connection	Quick connection terminal						
Display	LCD						
Smart meter	No	Yes					
CT connection	Plug terminal						
CT specification	Optional (Secondary current is 5A)						
<b>Features</b>							
Failsafe function	Yes						
Remote upgraded	Yes						
PF adjustment	No	Yes					
Control time	5 s						
<b>CT specification</b>							
	Specification	Dimensions (mm)			Hole size (mm)		Ratio
		W	H	D	a	e	
	CT-30×20-100 A	90	114	40	22	32	100:5 A
	CT-60×40-300 A	114	140	36	42	62	300:5 A
	CT-80×40-600 A	122	162	40	42	82	600:5 A
	CT-80×40-1000 A	122	162	40	42	82	1000:5 A
	CT-160×80-2000 A	184	254	52	82	162	2000:5 A
CT-160×80-3000 A	184	254	52	82	162	3000:5 A	

(1) The installed capacity of the inverter cannot exceed 5MW.

# SolisCloud: Intelligent Solar Energy System Monitoring

The SolisCloud intelligent monitoring system includes hardware and software products and is a comprehensive energy management solution. Hardware products, including data stick, data box, EPM and PLC, etc; transmit to SolisCloud online energy management platform. Real-time monitoring, visualized management and remote O & M of residential, C&I and utility scale solar PV plants.

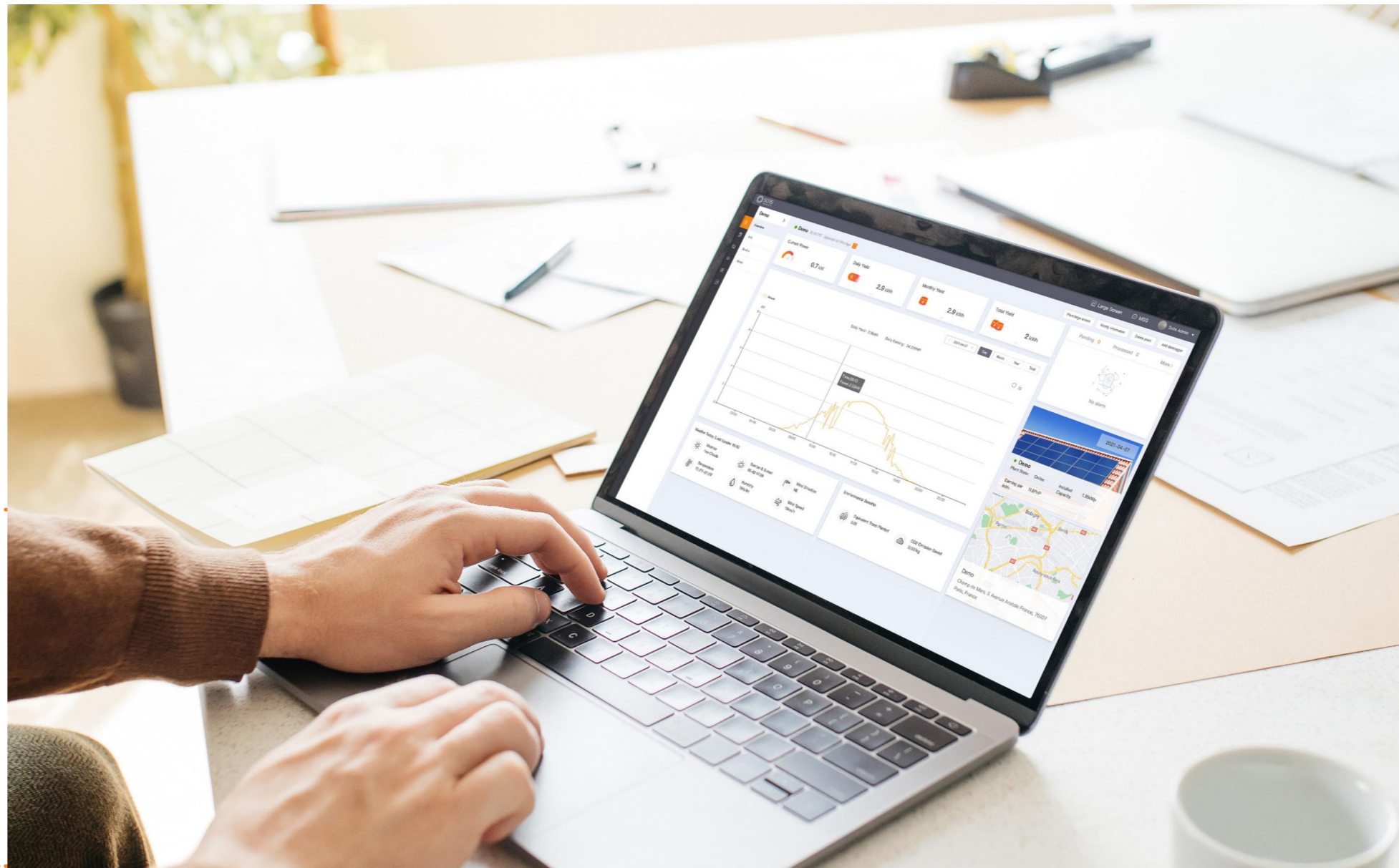

## S2-WL-ST



S2-WL-ST (4 Pin)

S2-WL-ST (USB)

## S3-GPRS/WiFi-ST



S3-GPRS-ST

S3-WiFi-ST

## S4-WiFi-ST



S4-WiFi-ST

## S1-W4G-ST



S1-W4G-ST (4 Pin)

S1-W4G-ST (USB)

## Solis-Link: RF



RF-Stick

RF Gateway

## SolisCloud

### New generation Solis PV monitoring platform

SolisCloud is the new generation of intelligent PV system monitoring. This new monitoring platform will empower you like never before. You will have full control of your system whenever and wherever you are. You will benefit from upgraded accurate fault alarm messaging that is adjustable to notify you within hours that fit meet your needs.

For simple O&M the new platform features a full size display of all your installations with real-time data. You will have an intelligent alarm system that gives recommendations to quickly repair your field faults. In depth analysis tools allow you to understand the overall health of your system. IV curve scanning can be done easily and quickly on your whole system. A live power flow display gives visibility of both standard solar systems as well as storage systems. Most importantly you will have complete control of your systems and be able to monitor and adapt anything when and how you want.

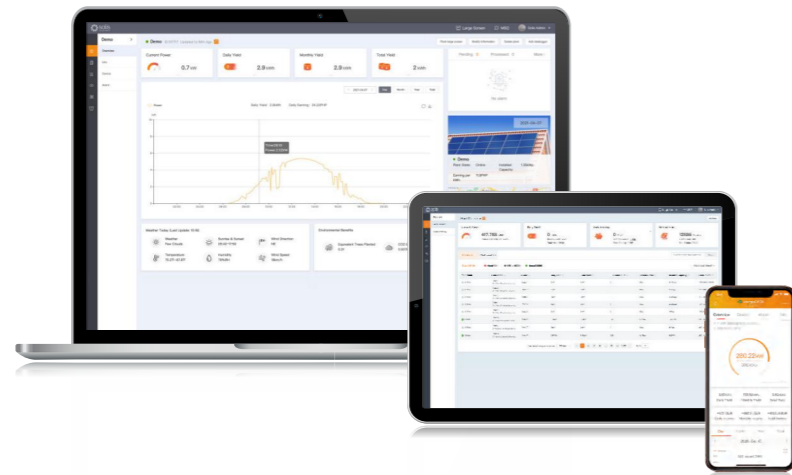

#### Intelligent Monitoring Solution - SolisCloud

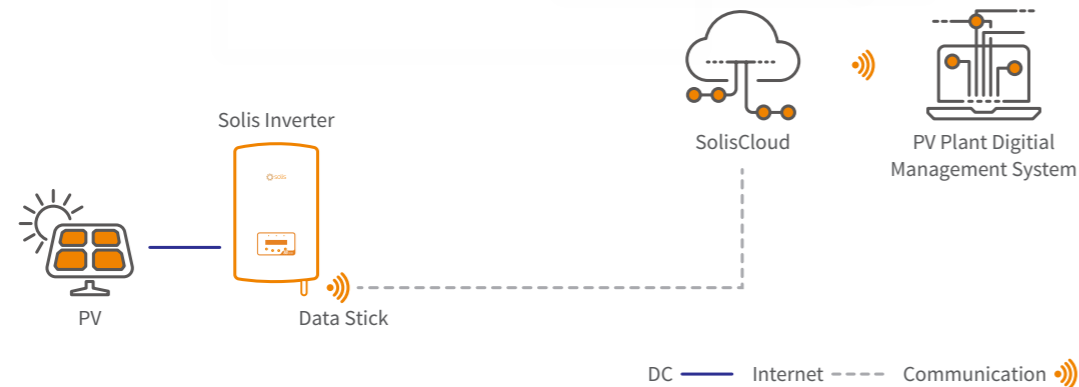

#### Advanced Cloud Platform

- Connecting with multiple types of devices seamlessly: Inverters, export power managers, weather stations, etc.

#### Efficient O & M

- Smart I-V curve scan, system health report, string-level fault finding

#### Multiple Plant Management

- Manage multiple types of systems across residential, commercial and utility scale plants. Enables multiple team management across different sectors

#### Multiple Plant Management

- Clear and concise display of system performance and benefits including carbon emissions saved and equivalent trees planted as well as showing system yield & earnings

### Download the App



#### Accessories available:

- S2-WL-ST
- S3-GPRS/WiFi-ST
- S4-WiFi-ST
- S1-W4G-ST
- Solis-Link: RF

Search for "Solis"



FOLLOW US

The Full Series of Operation Videos Will be available on **Youtube**

## S2-WL-ST

### Accessories - Solis Data Logging Stick

Use RS485 communication method to connect the inverters, up to 10 inverters can be connected at the same time. Data communication with the monitoring system through wireless WiFi network or LAN, which can realize remote control and monitoring. The network transmits intuitive data, which is convenient for customers to monitor anytime and anywhere.

#### Features:

- Support WiFi and LAN communication
- Status indicator, easy to display working status
- RESET button, one key to send data, convenient debugging
- Plug and play, quick installation
- Fault alarm, real-time monitoring
- Support Bluetooth nearby connection and debugging
- One-key assignment of inverter address, efficient and labor-saving



S2-WL-ST (4 Pin)



S2-WL-ST (USB)

#### Intelligent Monitoring Solution - S2-WL-ST

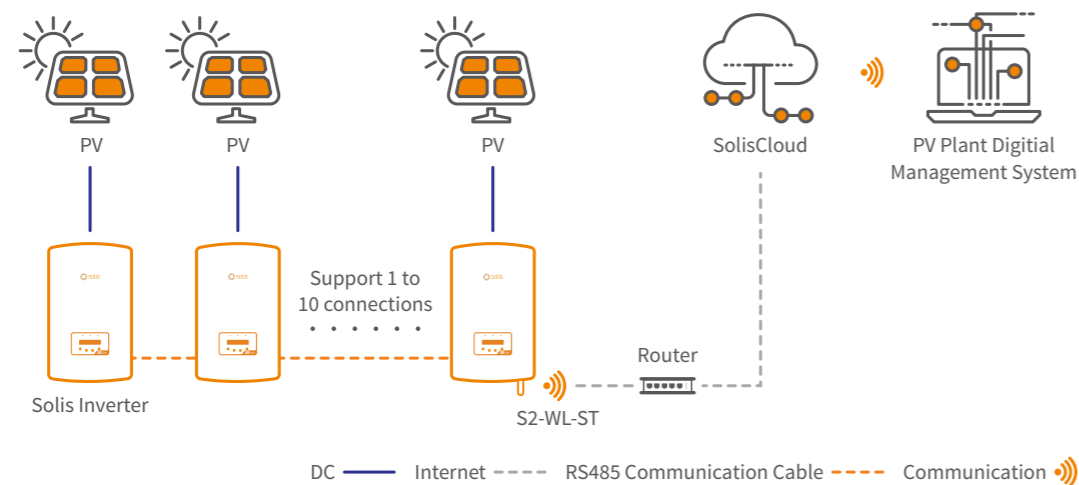

## DATASHEET

## S2-WL-ST

Models	S2-WL-ST (4 Pin)	S2-WL-ST (USB)
<b>Communication</b>		
Supported device type	Solis inverter	
Number of connected inverters <sup>(1)</sup>	≤10	
Data collection intervals	5 minutes	
Status indicator	LED × 3	
Communication interface	4 Pin	USB
Wireless communication	802.11b/g/n (2.4G—2.483G)	
Configuration method	APP/WEB	
<b>Electrical</b>		
Operating voltage	DC 5 V (+/-5%)	
Operating power consumption	≤5 W	
<b>Environment</b>		
Operating temperature	-30 ~ +65°C	
Operating humidity	5%-95%, Relative humidity, no condensa	
Storage temperature	-40 ~ +70°C	
Storage humidity	< 40%	
Operating altitude	≤4000 m	
Protection degree	IP65	
<b>Mechanical</b>		
Dimensions (L*W*H)	125*34*49 mm	112*34*49 mm
Installation method	Insert+Screw	Insert+Lock
Weight	103 g	89 g
<b>Others</b>		
Certification	CE, FCC	

(1) Connect the inverters by RS485 cables.



## S3-GPRS/WiFi-ST

### Accessories - Solis Data Logging Stick

Use RS485 communication method to connect the inverter, and data connection through wireless WiFi network or GPRS, which can realize remote control and monitoring. The network transmits intuitive data, which is convenient for customers to monitor at any time and place.

#### Features:

- Fault alarm, real-time monitoring
- Status indicator, easy to display working status
- Plug and play, convenient and fast
- RESET button, one key to send data, convenient debugging



S3-GPRS-ST

S3-WiFi-ST

#### Intelligent Monitoring Solution - S3-GPRS/WiFi-ST

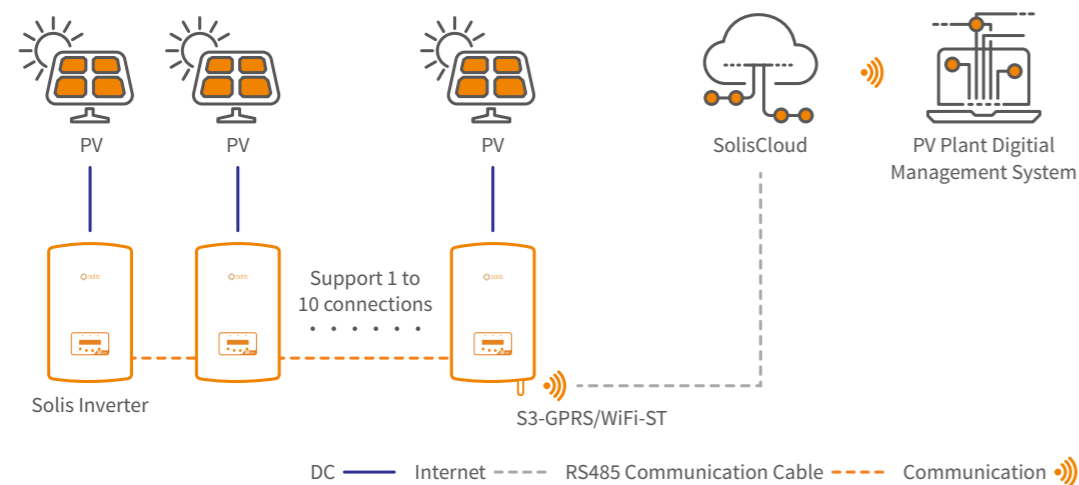

## DATASHEET

## S3-GPRS/WiFi-ST

Models	S3-GPRS-ST	S3-WiFi-ST
<b>Communication</b>		
Supported device type	Solis inverter	
Number of connected inverters <sup>(1)</sup>	≤10	
Data collection intervals	5 minutes	
Status indicator	LED × 3	
Communication interface	4 Pin	
Wireless communication	850/900/1800/1900 MHz	802.11b/g/n (2.4G—2.483G)
Configuration method	APP/WEB	
<b>Electrical</b>		
Operating voltage	DC 5V(+/-5%)	
Operating power consumption	≤5 W	
<b>Environment</b>		
Operating temperature	-30 ~ +65°C	
Operating humidity	5%-95%, relative humidity, no condensa	
Storage temperature	-40 ~ +70°C	
Storage humidity	< 40%	
Operating altitude	≤4000 m	
Protection degree	IP65	
<b>Mechanical</b>		
Dimensions (L*W*H)	133*45*41 mm	128*50*34 mm
Installation method	Insert+Screw	
Weight	84 g	80 g
<b>Others</b>		
Certification	CE	CE, FCC

(1) Connect the inverters by RS485 cables.

## S4-WiFi-ST

### Accessories - Solis Data Logging Stick

Use RS485 communication method to connect the inverters, up to 10 inverters can be connected at the same time. Data communication with the monitoring system through wireless WiFi network, which can realize remote control and monitoring. The network transmits intuitive data, which is convenient for customers to monitor anytime and anywhere.

#### Features:

- Fault alarm, real-time monitoring
- Plug and play, convenient and fast
- Status indicator, easy to display working status
- RESET button, one key to send data, convenient debugging



S4-WiFi-ST

#### Intelligent Monitoring Solution - S4-WiFi-ST

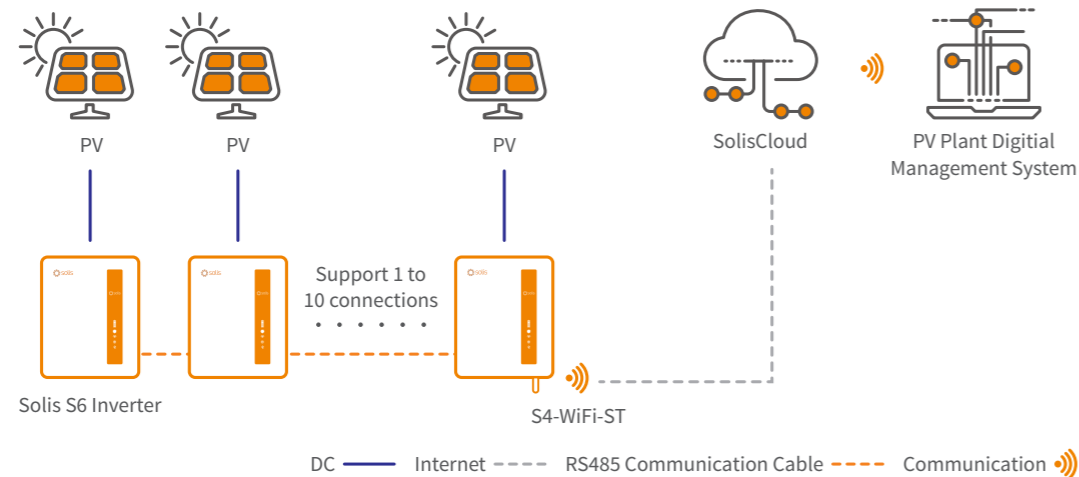

## DATASHEET

## S4-WiFi-ST

Models	S4-WiFi-ST
<b>Communication</b>	
Supported device type	Solis inverter
Number of connected inverters <sup>(1)</sup>	≤10
Data collection intervals	5 minutes
Status indicator	LED × 3
Communication interface	USB
Wireless communication	802.11b/g/n (2.4G—2.483G)
Configuration method	APP/WEB
<b>Electrical</b>	
Operating voltage	DC 5V(+/-5%)
Operating power consumption	≤5 W
<b>Environment</b>	
Operating temperature	-30 ~ +65°C
Operating humidity	5%-95%, relative humidity, no condensa
Storage temperature	-40 ~ +70°C
Storage humidity	< 40%
Operating altitude	≤4000 m
Protection degree	IP65
<b>Mechanical</b>	
Dimensions (L*W*H)	128*50*34 mm
Installation method	Insert+Screw
Weight	84 g
<b>Others</b>	
Certification	CE, FCC

(1) Connect the inverters by RS485 cables.

## S1-W4G-ST

### Accessories - Solis Data Logging Stick

Use RS485 communication method to connect the inverters, up to 10 inverters can be connected at the same time. Data communication with the monitoring system through wireless WiFi network or 4G, which can realize remote control and monitoring. The network transmits intuitive data, which is convenient for customers to monitor anytime and anywhere.

#### Features:

- Support WiFi and 4G communication
- Status indicator, easy to display working status
- RESET button, one key to send data, convenient debugging
- Fault alarm, real-time monitoring
- Support Bluetooth nearby connection and debugging
- One-key assignment of inverter address, efficient and labor-saving



S1-W4G-ST (4 Pin)



S1-W4G-ST (USB)

#### Intelligent Monitoring Solution - S1-W4G-ST

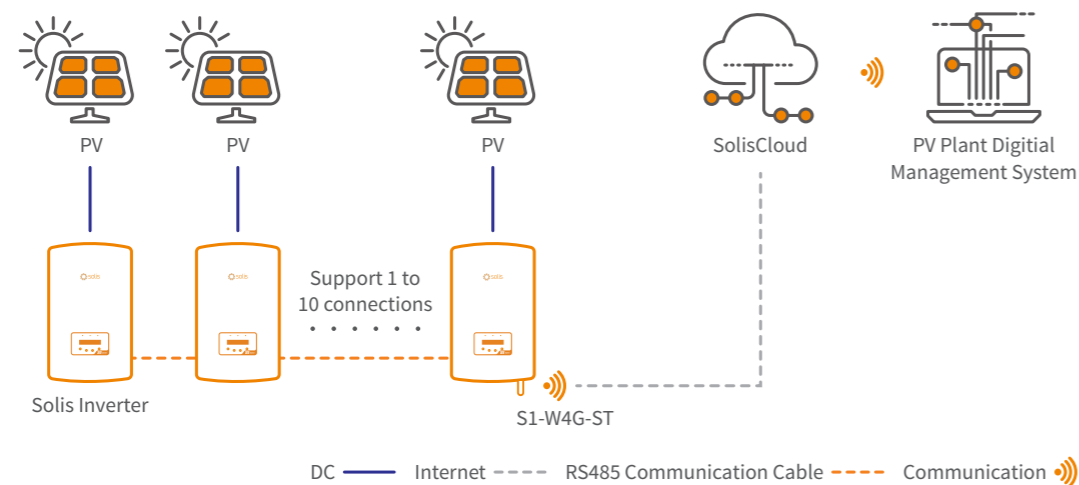

## DATASHEET

## S1-W4G-ST

Models	S1-W4G-ST (4 Pin)	S1-W4G-ST (USB)
<b>Communication</b>		
Supported device type	Solis inverter	
Number of connected inverters <sup>(1)</sup>	≤10	
Data collection intervals	5 minutes	
Status indicator	LED × 3	
Communication interface	4 Pin	USB
Wireless communication	802.11b/g/n (2.4G—2.483G) GSM/GPRS: 850/900/1800/1900 MHz	
Configuration method	APP/WEB	
<b>Electrical</b>		
Operating voltage	DC 5 V (+/-5%)	
Operating power consumption	≤5 W	
<b>Environment</b>		
Operating temperature	-30 ~ +65°C	
Operating humidity	5%-95%, Relative humidity, no condensa	
Storage temperature	-40 ~ +70°C	
Storage humidity	< 40%	
Operating altitude	≤4000 m	
Protection degree	IP65	
<b>Mechanical</b>		
Dimensions (L*W*H)	128*50*34 mm	115*50*34 mm
Installation method	Insert+Screw	Insert+Lock
Weight	79 g	65 g
<b>Others</b>		
Certification	CE, FCC	

(1) Connect the inverters by RS485 cables.

## Solis-Link: RF

### Accessories - Solis Data Logging Device

Solis box type (gateway) + stick type (terminal) monitoring data collector, the terminal uses RS485 communication to connect to the inverter, the gateway uses wired Ethernet to connect to the home router, and the gateway and terminal are connected through RF data to realize automatic networking. The equipment is connected to the gateway automatically, free of wiring and wireless network configuration; it aims to realize a stable and intelligent operation and maintenance management plan for users.

#### Features:

- Plug and play, easy to operate
- No Wi-Fi configuration required, RF intelligent connection
- Stable network connection, real-time data transmission
- Remote monitoring, allowing real-time monitoring of mobile APP and Web side



RF-Stick



RF Gateway

### Intelligent Monitoring Solution - Link: RF

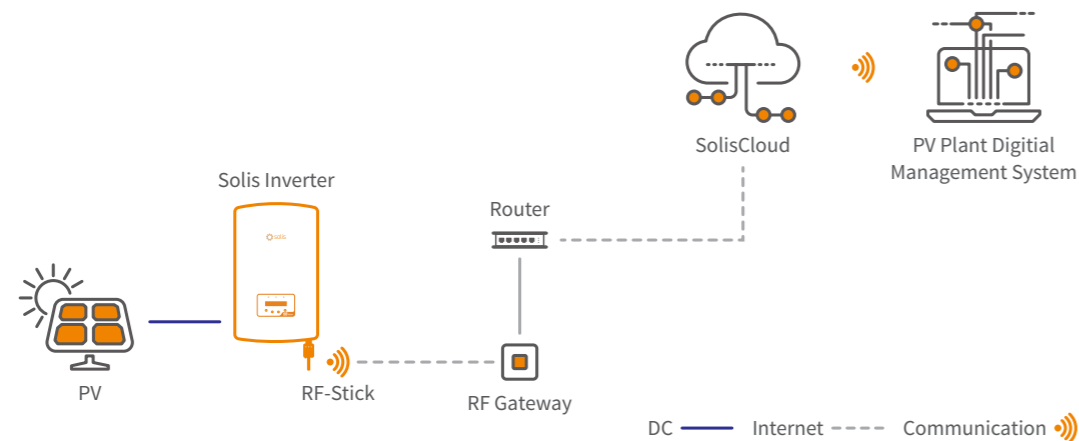

## DATASHEET

## Solis-Link: RF

Models	RF-Stick	RF-Gateway
<b>Wireless parameters</b>		
Demodulation		FSK
Data rate		9.6 kbps
Transmitting power		+20 dBm
Transmitting frequency offset		20 kHz
Transmission channel bandwidth		<8 kHz
Receiving channel bandwidth		200 kHz
<b>Hardware parameters</b>		
Data interface	RS 485	Adaptive 10 / 100 Mbps
Operating voltage	DC 5 V ~ DC 12 V	DC 5.0 V (+/-5%)
Max. working voltage	15 V	12 V
Operating power consumption	1.5 W	
Indicator light	System running Status--RUN Light Inverter Connection Status--COM Light RF Connection Status--RF Light	System running Status--RUN Server Connection Status--SER RF Connection Status--RF
Operating humidity	10%-90%, relative humidity, no condensa	
Storage temperature	-45 ~ +90°C	
Storage humidity	< 40%	
<b>Software parameters</b>		
Number of connected inverters	1	/
Serial communication rate	9600 bps (adjustable:1200-57600 bps)	/
Data collection intervals	5 minutes	/
Link requirement	/	CAT5 shielded network cable length <50 m
<b>Mechanical</b>		
Dimensions (L*W*H)	47*41*160 mm	90*23*90 mm
Weight	130 g	80 g
Protection degree	IP 65	IP 21
<b>Others</b>		
Certification	CE	

# Contact Us

## HQ

- +86 574 6580 2188
- sales@ginlong.com service@ginlong.com
- No. 188 Jinkai Road, Binhai Industrial Park, Xiangshan, Ningbo, Zhejiang, 315712, P.R.China

## UK

- +44 113 328 0870
- europesales@solisinverters.com euservice@solisinverters.com
- 1 Church Street Bootle Liverpool, L20 1AF, UK

## Mexico

- +86 574 6580 2188 (sales) +52 81 3434 2092 (service, WhatsApp only)
- sales@ginlong.com service.latam@solisinverters.com
- Monterrey, Mexico

## South Africa

- +27 010 222 0181
- sales@ginlong.com saservice@solisinverters.com
- 1487 Seilskip Road, Laser Park, Honeydew, Roodepoort, Gauteng, South Africa

## Poland

- +44 113 328 0870 (sales) +48 221 031 937 (service)
- europesales@solisinverters.com plservice@solisinverters.com

## Spain (EU Service Center)

- +34 914 430 810 (sales) +34 919 495 286 (service)
- europesales@solisinverters.com spservice@solisinverters.com
- Calle de Serrano, 240 - 1ª planta 28016 Madrid, Spain

## Netherlands

- +31 85 048 1300
- benelux@solisinverters.com nlservice@solisinverters.com
- Nokweg 3-B, 2451 AL Leimuiden, Nederland

## Australia

- +61 3 8555 9516
- sales@solisinverters.com.au service@solisinverters.com.au
- No. 5 / 109 Tulip Street, Cheltenham, Vic. 3192 Australia

## India

- +91 224 9744 251 (sales) +91 224 9744 021 (service)
- indiasales@ginlong.com inservice@solisinverters.com
- 104, wing -A, 1st floor, Techno1 City Premises Plot no. X-4/1 Mahape Navi Mumbai- 400710, India

## USA/ Canada

- +1 866 438 8408
- ussales@solisinverters.com usservice@solisinverters.com

## Vietnam

- +84 98 316 8126 (sales) +84 89 917 6618 (service)
- sales@ginlong.com service@ginlong.com
- 38/21 Đ. Lố Ổ, Xã Bình Thắng, Dĩ An, Bình Dương, Việt Nam

## Brazil

- +55 19 996133803 (sales) +55 19 999618000 (service, WhatsApp)
- sales@ginlong.com service@ginlong.com
- Sala 618, R. Paulo César Fidélis, 39-Lot. Res. Vila Bella, Campinas-SP, Brasil, 13087-727

## Myanmar

- +95 94 302 3335
- sales@ginlong.com service@ginlong.com
- No (10) Sagwar Pin Street, Kyimyindaing, Yangon City

## Sweden

- +46 725 344 987 (sales) +46 850 282 408 (service)
- europesales@solisinverters.com seservice@solisinverters.com
- Åkersberga, Sweden

## Romania

- +40 373 808 894
- europesales@solisinverters.com euservice@solisinverters.com
- Brasov, Romania

## Malaysia

- +60 016 232 3512
- sales@ginlong.com service@ginlong.com
- Jalan Kelang Lama, 58200 Kuala Lumpur, Malaysia

## Pakistan

- +82 32 822 2188 (sales) +92 042 3232 1222 (service)
- sales@ginlong.com service@ginlong.com
- Lahore, Punjab, Pakistan

## Singapore

- +82 32 822 2188 (sales) +60 016 232 3512 (service)
- sales@ginlong.com service@ginlong.com

## Korea

- +82 32 822 2188
- sales@ginlong.com service@ginlong.com
- #A-615, Smart Valley, 30 Songdomirae-ro, yeonsu-gu, Incheon, Korea

## Philippines

- +63 967 008 1263
- sales@ginlong.com service@ginlong.com
- 12-2C, Cambridge Village Condominium, BLK 19 Kabisig Road, San Andre's Floodway, Cainta Rizal, 1900

## Germany

- +49 322 12 249 144
- europesales@solisinverters.com
- deservice@solisinverters.com

## Turkey

- +90 545 651 3541 (sales) +86 574 6580 2188 (service)
- europesales@solisinverters.com euservice@solisinverters.com
- Istanbul, Turkey

## Italy

- +39 02 8295 7352
- europesales@solisinverters.com itservice@solisinverters.com
- Treviso, Italy

## Thailand

- +66 085 155 1936
- sales@ginlong.com service@ginlong.com
- Vibhavadi Rangsit Road, Chatucha, Bangkok 10900, Thailand

## Indonesia

- +82 32 822 2188 (sales) +62 0813 8591 8539 (service)
- sales@ginlong.com service@ginlong.com
- Kunciran Pinang, Tangerang, Indonesia

## France

- +34 914 430 810 (sales) +33 971 078 736 (service)
- europesales@solisinverters.com euservice@solisinverters.com

## Chile

- +82 32 822 2188 (sales) +52 811 500 2841 (service, WhatsApp only)
- sales@ginlong.com service@ginlong.com

