

Insulated Roof & Wall Panels
UK & Republic of Ireland

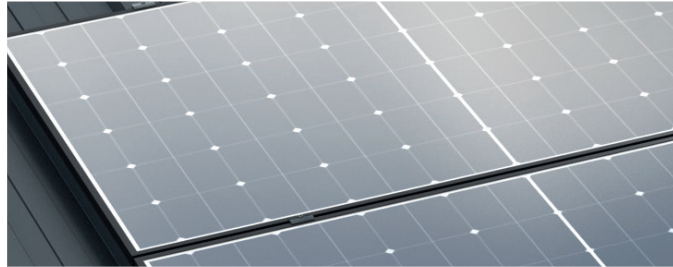

















Kingspan PowerRail RW Rooftop Solar PV Mounting System Installation Guide



Kingspan PowerRail RW Rooftop Solar PV Mounting System

Installation Guide









General Notes

-  This document should be read by all operatives involved in the installation of the Kingspan PowerRail RW PV mounting system.
-  A copy of this installation manual should always be kept on site during the installation of the Kingspan PowerRail RW PV mounting system.
-  A copy of this installation manual should be kept and added to the operation and maintenance manual for the entire PV system.
-  The Kingspan PowerRail RW PV mounting system may only be installed by persons who are both technically capable and qualified to do so. This includes, but is not limited to, all relevant training in relation to working at height.
-  All construction work should adhere to governing, local and national, building permissions and planning regulations.
-  Prior to the installation of the Kingspan PowerRail RW PV mounting system and array, ensure the design has been carried out to all local wind and snow loading requirements.
-  Prior to the installation of the Kingspan PowerRail RW PV mounting system and array, ensure the roofing material and the underlying structural components have been assessed and approved for their ability to support the additional loading as a result of the installation of the array, by a suitably qualified Structural Engineering company.
-  Prior to the installation of the Kingspan PowerRail RW PV mounting system it is recommended that the QuadCore® KS1000RW Roof Panel be surveyed to document its condition. This should include, but is not limited to, the condition of coatings, weather seals, fixings and any existing penetrations in the roof.
-  The installation instructions of the solar PV module manufacturer must always be adhered to. Should a conflict arise between the mounting system design and the installation instructions of the solar PV module manufacturer contact the solar PV module manufacturer directly for further technical guidance.
-  Consideration must be given to the layout and positioning of the PV array when installing in the presence of Kingspan Day-Lite Trapezoidal Rooflight products. Adequate clearance should be provided for future maintenance of both the PV array and the Kingspan Day-Lite Trapezoidal Rooflight products. For further information on the layout and positioning of the PV array please see the Kingspan Solar PV design guide.
-  The Kingspan PowerRail RW PV mounting system is not designed to fix into the trapezoidal profile of the Kingspan Day-Lite Trapezoidal Rooflight range of products.
-  The Kingspan PowerRail RW PV mounting system is designed to be fixed into the central crowns of the QuadCore® KS1000RW Roof Panel only.
-  The Kingspan PowerRail RW PV mounting system IS NOT designed to be fixed into the overlapping side crown between two adjacent QuadCore® KS1000RW Roof Panels.
-  Only the fixings provided with the Kingspan PowerRail RW PV mounting system are to be used, substitution or modification of these fixings will alter the structural performance of the product and nullify all design calculations and warranties.
-  Impact drivers must not be used for the installation of the Kingspan PowerRail RW PV mounting system. Over tightening of fixings and/or module clamps may impact their structural and sealing performance.
-  Array layouts should take into consideration the future maintenance of both the PV array and the QuadCore® KS1000RW Roof Panel.
-  During installation no tools, materials or any other equipment should be placed on the surface of the PV modules. This can lead to damage of coatings, glass or cells of the PV modules.

Kingspan PoweRail RW Rooftop Solar PV Mounting System

Installation Guide

Safety Notes

-  All operatives should wear appropriate personal protective equipment (PPE) as specified in the project health and safety plan as well as site specific RAMs (Risk and Method Statements), during the installation of the Kingspan PoweRail RW PV mounting system.
-  Solar PV modules are fragile elements. Installers should never walk on solar PV modules during installation, maintenance or removal. This includes solar PV module frames. Do not subject solar PV modules to any mechanical stress or allow any objects to be dropped on the solar PV modules.
-  There is an inherent risk of working at height when installing a rooftop PV array. The installation of the Kingspan PoweRail RW PV mounting system should adhere to a health and safety plan prepared based on a thorough project risk assessment. Safety equipment should be employed for the project in line with governing regulations.
-  The installation of a rooftop PV array introduces trip hazards at roof level. Ensure all walkways are clearly marked and kept clear of materials and tools. The project health and safety plan should highlight and account for any potential trip hazards.
-  There is a risk of falling materials when installing a rooftop PV array. Clear demarcation lines should be specified in the health and safety plan and be set up around the area of installation and any members of the public who have cause to be in the proximity of the site must be warned.
-  The installation, maintenance and removal of rooftop PV arrays exposes operatives to risk of electric shock. Solar PV modules generate electricity when exposed to daylight and cannot be switched off. The installation of solar PV modules must be carried out by operatives who are technically capable and qualified to do so.
-  Beware of all industrial machinery whether it is related to the installation of the rooftop array or part of the daily operation on the site of installation. The health and safety plan should highlight areas in which industrial machinery is in operation.
-  Beware of overhead loads while lifting material to and from the roof of installation. Designated lifting areas and clear demarcation lines should be specified in the health and safety plan and be set up as required. Members of the installation team and the public who have cause to be in the proximity of the lifting works must be warned.

Kingspan PowerRail RW Rooftop Solar PV Mounting System

Installation Guide

Components

Rail



Mid Clamp

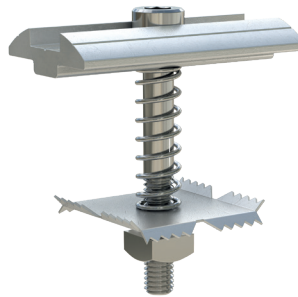

End Clamp

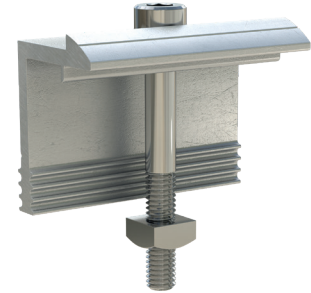

End Clamp Insert
(Module Frame >30mm)

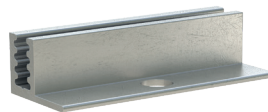

Fixings



Kingspan PowerRail RW Rooftop Solar PV Mounting System

Installation Guide

Required Tools

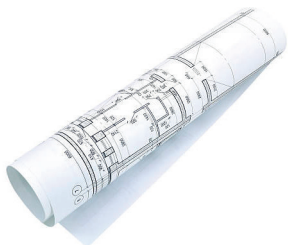

Construction drawings
for Mounting System



Installation manual
for Mounting System



Installation manual
for Modules



Marker / pencil



Torque wrench



5mm Hex bit



8mm Hex
drive tool



Tape measure



Depth
locator

Cordless screw driver
with depth locator (impact
drivers must not be used)

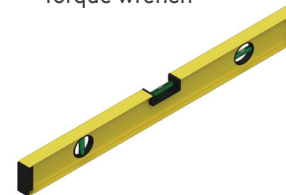

Spirit level

Notes: This installation guide should be read in conjunction with the 'project specific' design drawings and method statements.

Although this installation guide is deemed to be correct at the time of publication, Kingspan reserves the right to amend the information at any time in the future. Installation guides are available for all of Kingspan insulated roof and wall panels.

Kingspan PoweRail RW Rooftop Solar PV Mounting System

Installation Guide

Installation Instructions

1

Inspect all material upon delivery to site any damaged or missing material should be noted immediately and reported to the Kingspan.

2

Check all design documents provided and ensure all associated dimensions are in line with site conditions. Any discrepancies should be brought to the attention of the mounting system designer prior to the commencement of work.

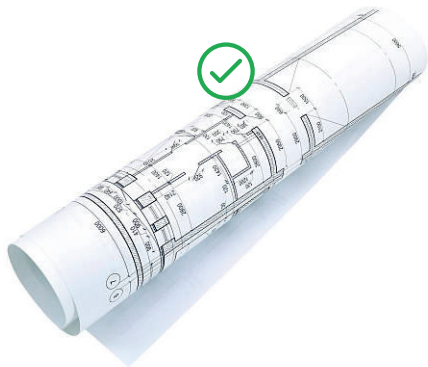

3

In particular, the position of roof sheet side lap joints, end lap joints, Day-Lite Trapezoidal Rooflights and existing roof sheet fasteners should all be noted prior to the commencement of the installation of the Kingspan PoweRail RW PV mounting system.

Should the positioning of the Kingspan PoweRail RW PV mounting system clash with any of these elements this should be brought to the attention of the mounting system designer prior to the commencement of work.

Please see 3a, 3b and 3c on the next page.

Kingspan PowerRail RW Rooftop Solar PV Mounting System

Installation Guide

Installation Instructions

3a

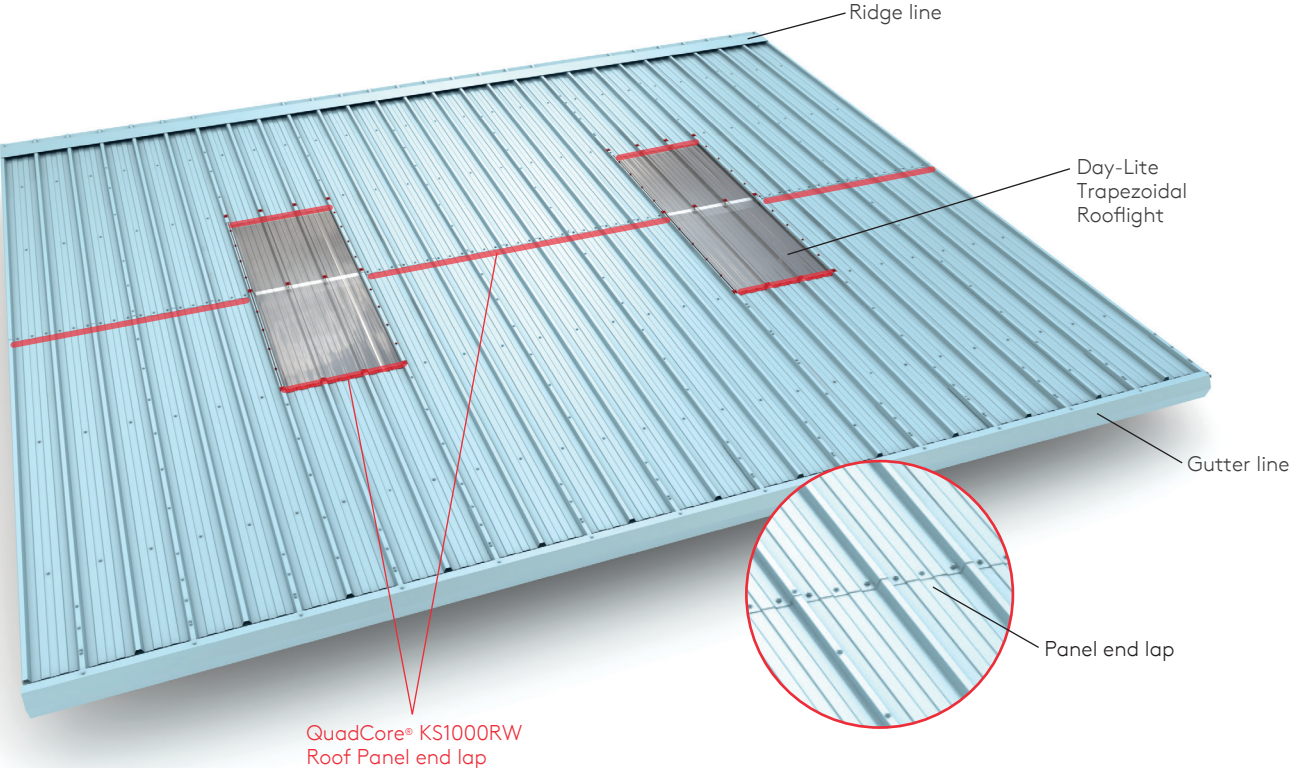

Kingspan PowerRail RW Rooftop Solar PV Mounting System

Installation Guide

Installation Instructions

3b

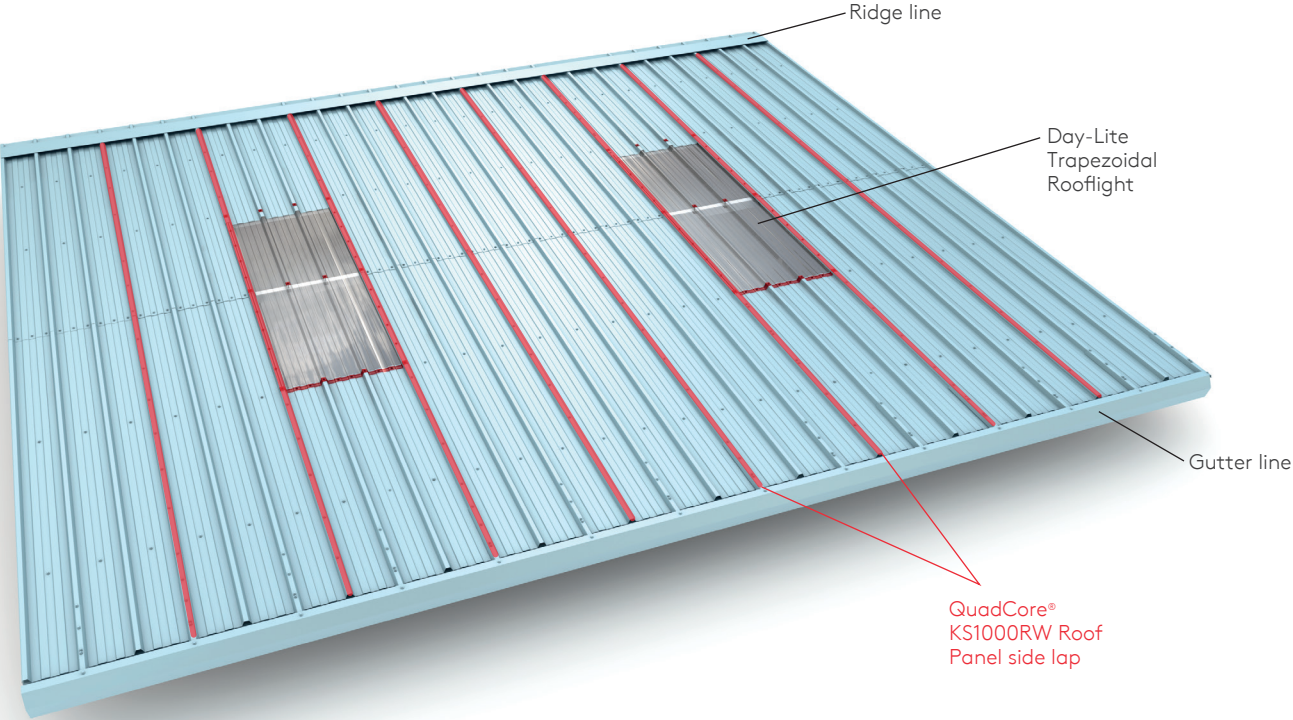

Kingspan PowerRail RW Rooftop Solar PV Mounting System

Installation Guide

Installation Instructions

3c

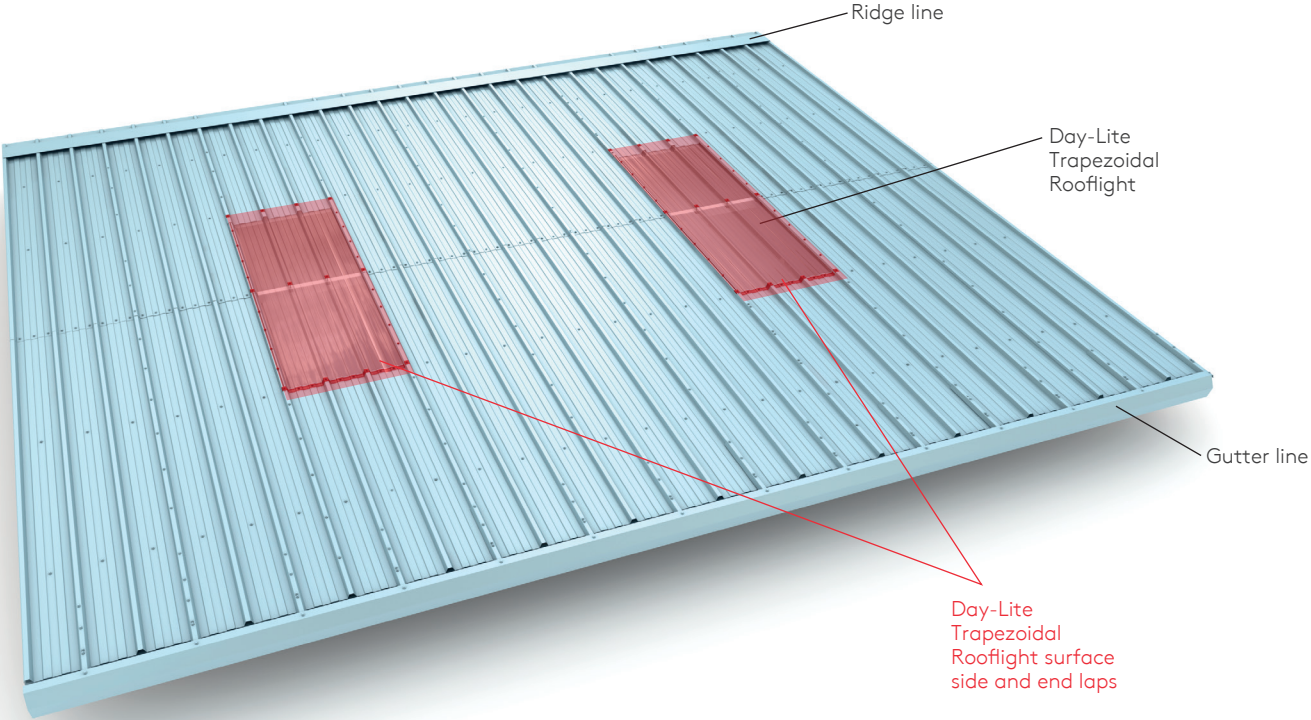

Kingspan PowerRail RW Rooftop Solar PV Mounting System

Installation Guide

Installation Instructions

4

For larger installations it is recommended to limit the number of modules in a column to 10.

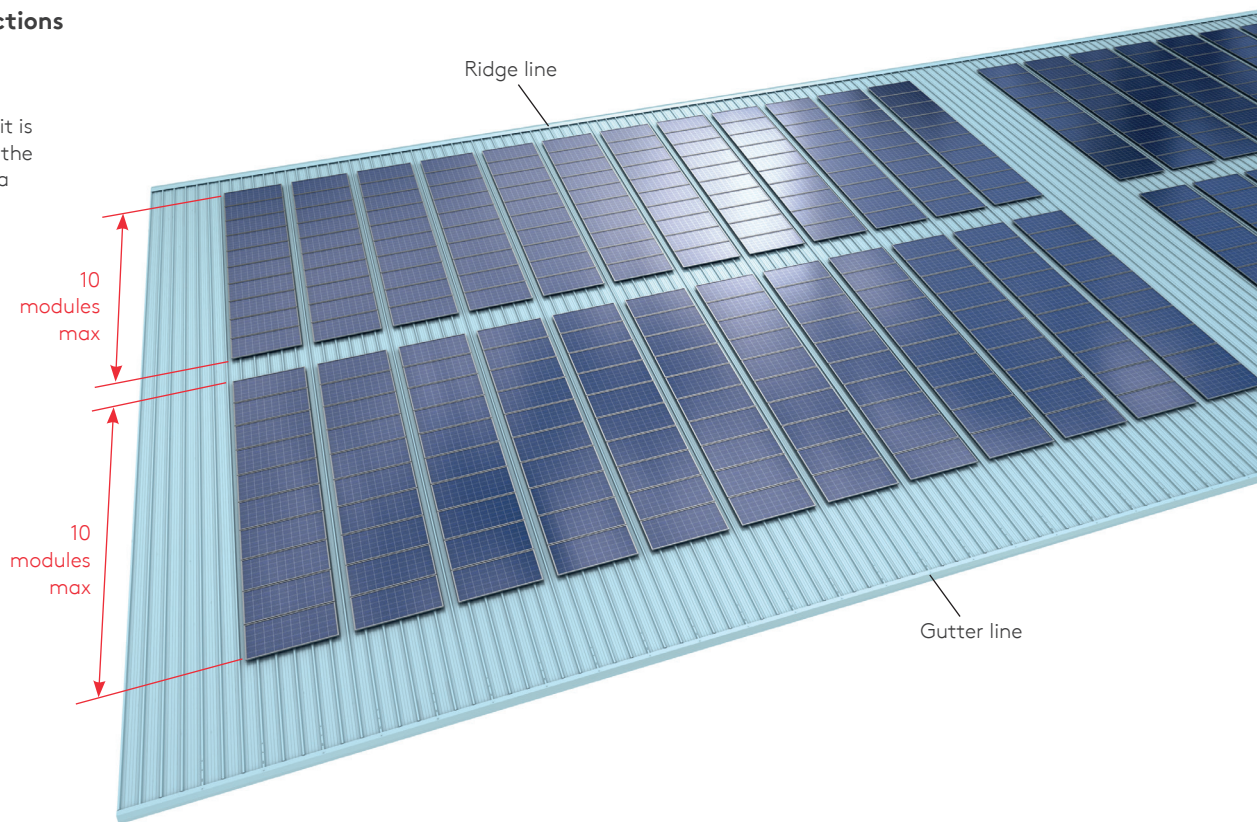

Kingspan PowerRail RW Rooftop Solar PV Mounting System

Installation Guide

Installation Instructions

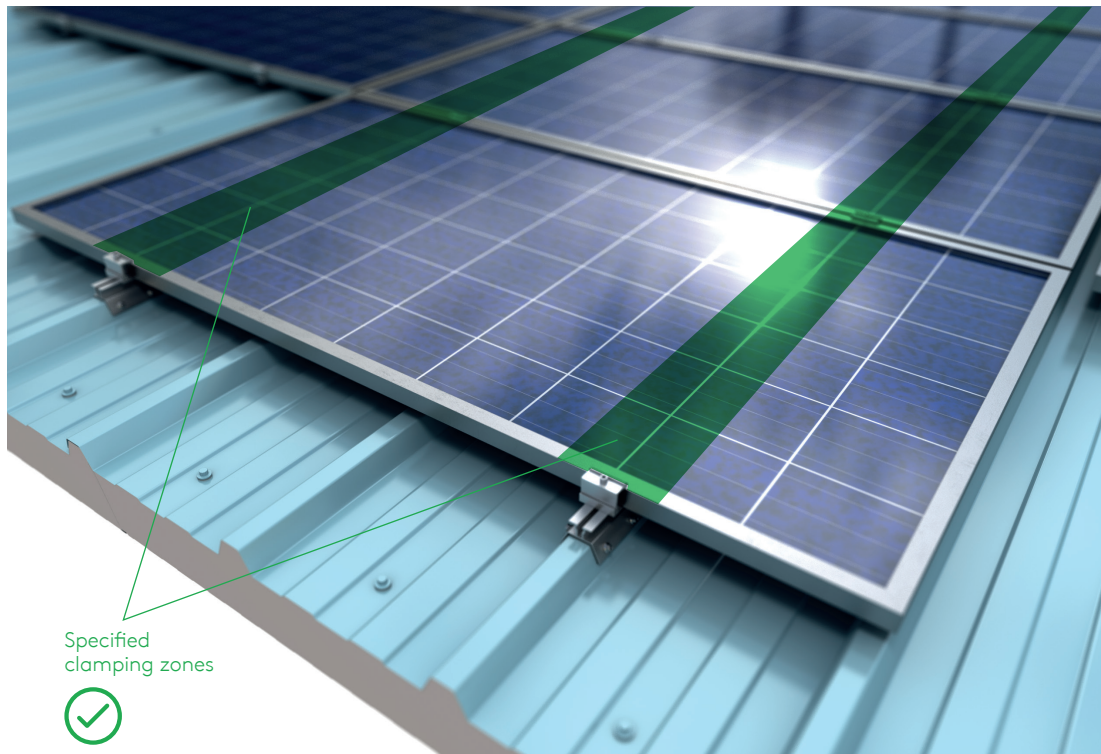

5a

Ensure that dimensions and Kingspan PowerRail RW PV mounting system positions are in line with the clamping and mounting zones specified in the installation manual of the solar PV module manufacturer.

Any discrepancies between dimensions noted on the drawings and those specified by the solar PV module manufacturer should be brought to the attention of the mounting system designer prior to the commencement of work.

The solar PV module manufacturer should be contacted directly for further technical guidance.

Kingspan PoweRail RW Rooftop Solar PV Mounting System Installation Guide

Installation Instructions

5b

If required, the areas where the Kingspan PoweRail RW PV mounting system is to be positioned should be cleaned to remove any residue which might impact the mounting system achieving a sufficient seal against the QuadCore® KS1000RW Roof Panel.

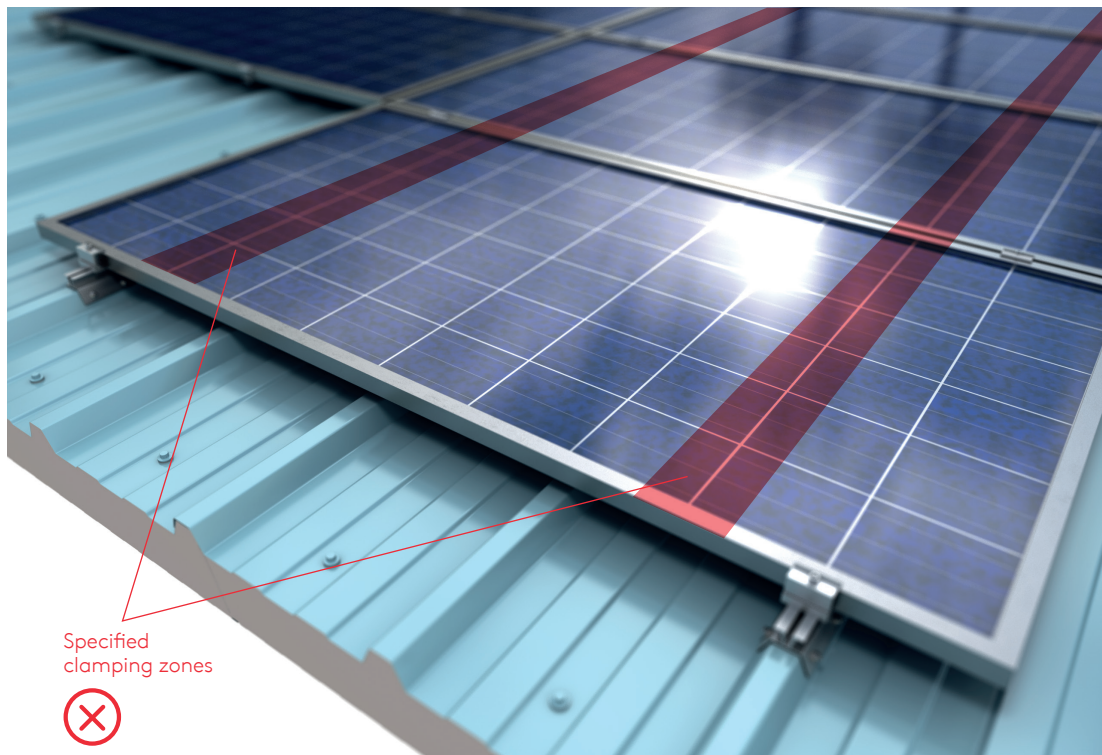

Kingspan PowerRail RW Rooftop Solar PV Mounting System

Installation Guide

Installation Instructions

6

Mark out the location of the rails on the roof as per the project design.

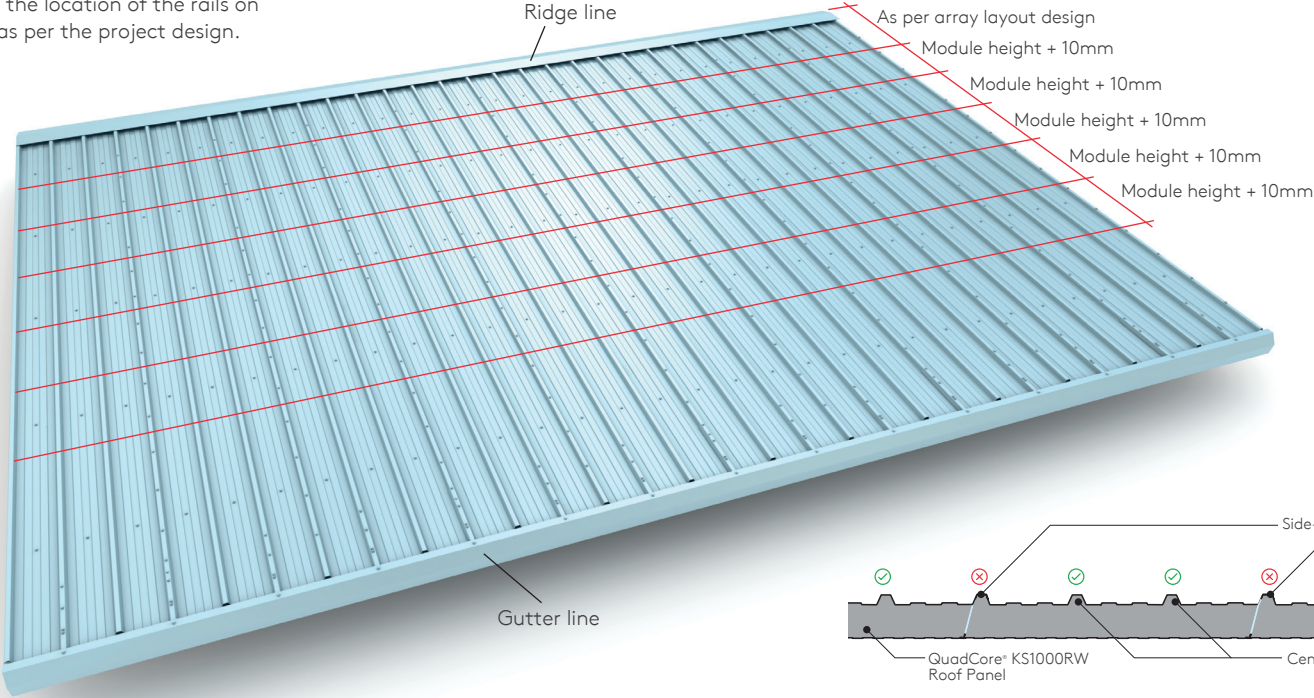

Kingspan PowerRail RW Rooftop Solar PV Mounting System

Installation Guide

Installation Instructions

7

Following the marking out the rails can be positioned on the central crown of the QuadCore® KS1000RW Roof Panel.

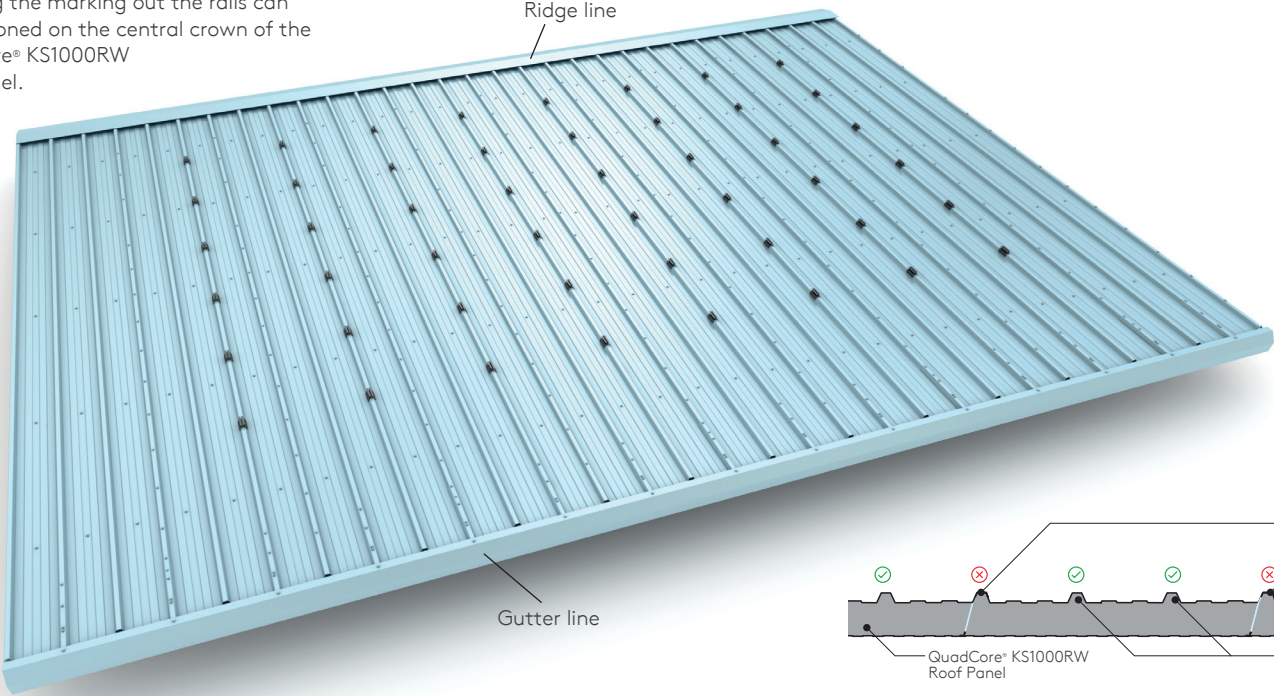

Kingspan PoweRail RW Rooftop Solar PV Mounting System

Installation Guide

Installation Instructions

Horizontal positioning of the PoweRail will be subject to the module being installed and module manufacturers installation manual.

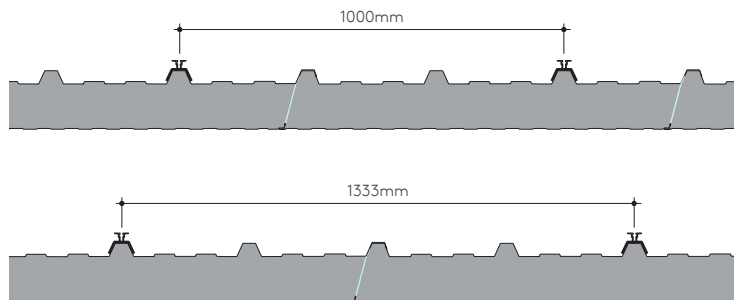

8

Press down on the rail ensuring it is seated correctly, level and that the protective PVC foam tape is compressed against the QuadCore® KS1000RW Roof Panel. Compression of the PVC foam tape is necessary to ensure a seal.

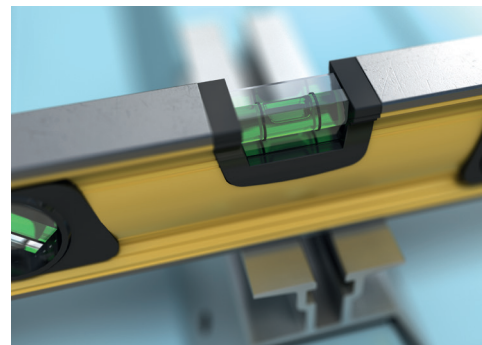
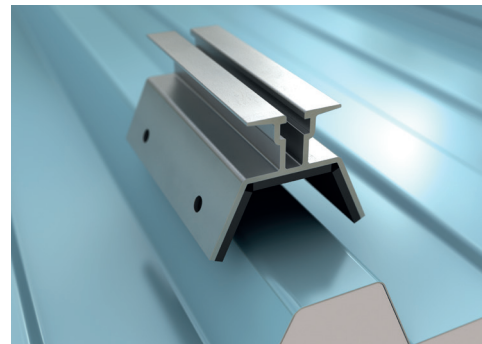

Kingspan PoweRail RW Rooftop Solar PV Mounting System

Installation Guide

Installation Instructions

9

While maintaining downward pressure on the rail insert (4No.) fixings screws to secure to the crown. Use a cross fixing pattern to avoid uneven fixing of the rail.

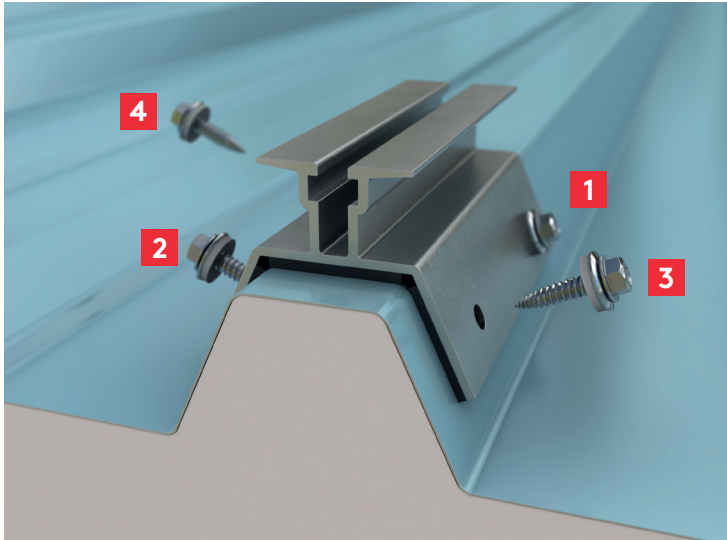

10

Only the fixings provided with Kingspan PoweRail RW are to be used for installation.

Ensure rail is seated correctly and level during the installation of the screw. Under no circumstance are alternative fixings to be used for installation.

The speed of the cordless screwdriver should not exceed 1,800rpm during the installation of the fixings.

To avoid over tightening the fixing or stripping the steel of the roof sheet, an appropriate depth stop must be used when installing all fixings.

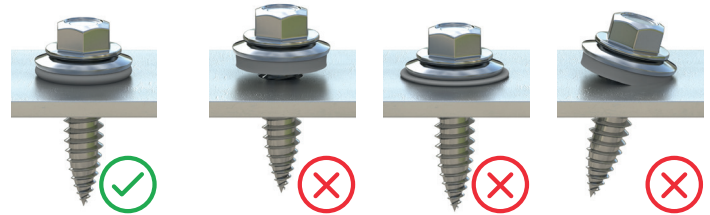

Kingspan PowerRail RW Rooftop Solar PV Mounting System

Installation Guide

Installation Instructions

11

Module end-clamp insert can be adjusted to suit a range of module frame depths.



No clamp insert
30mm module frame



Clamp insert –
Position 1
31-33mm module
frame



Clamp insert –
Position 2
34-35mm module
frame



Clamp insert –
Position 3
36-38mm module
frame



Clamp insert –
Position 4
39-40mm module
frame

Kingspan PowerRail RW Rooftop Solar PV Mounting System

Installation Guide

Installation Instructions

12

Beginning from the lowest point of the array insert the module end clamp into the corresponding slot on the rail. The end clamp should be positioned centrally on the Kingspan PowerRail RW.

Repeat this process for the adjacent rail and ensure both end clamps are aligned.

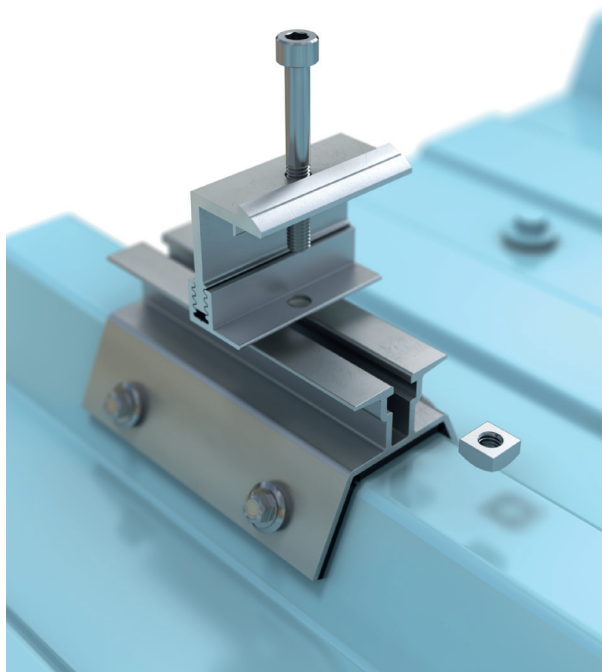

Ensure the clamp nut is in the correct orientation prior to installation. The flat surface of the nut should be facing upwards with the chamfered surface facing downwards.

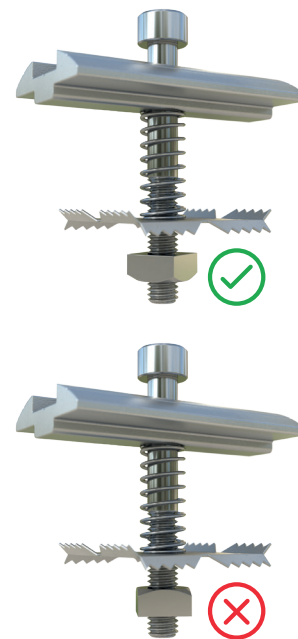

Kingspan PowerRail RW Rooftop Solar PV Mounting System

Installation Guide

Installation Instructions

13

Module end clamps must never be installed at the edge of a rail.

Design and layout should ensure that the clamp bolts are positioned in the centre of the rail.

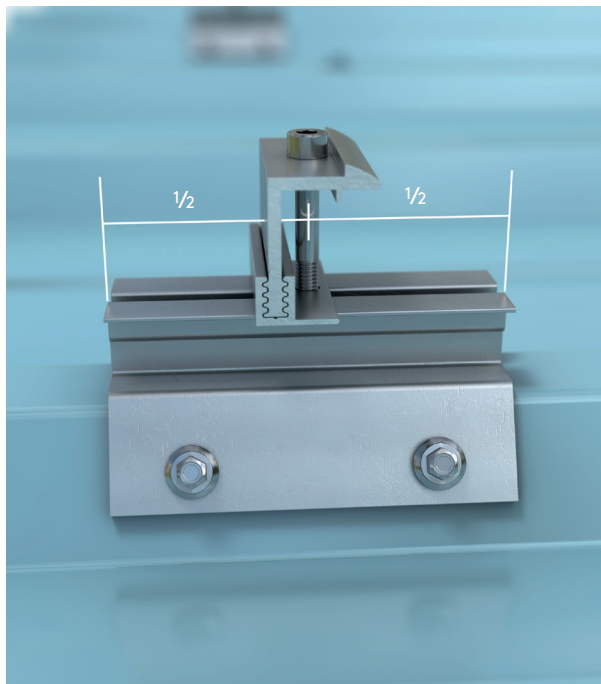

Clamp must not be installed within 20mm of the end of the PowerRail.

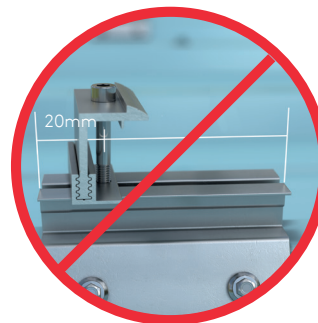

Kingspan PowerRail RW Rooftop Solar PV Mounting System

Installation Guide

Installation Instructions

14a

Insert and align the first solar PV module prior to final tightening of the module end clamps. Solar PV modules should only be clamped in the zones / positions as recommended by the solar PV module manufacturer.

Any discrepancies between dimensions noted in the project design and those specified by the solar PV module manufacturer should be brought to the attention of the mounting system designer prior to the commencement of work.

The solar PV module manufacturer should be contacted directly for further technical guidance.

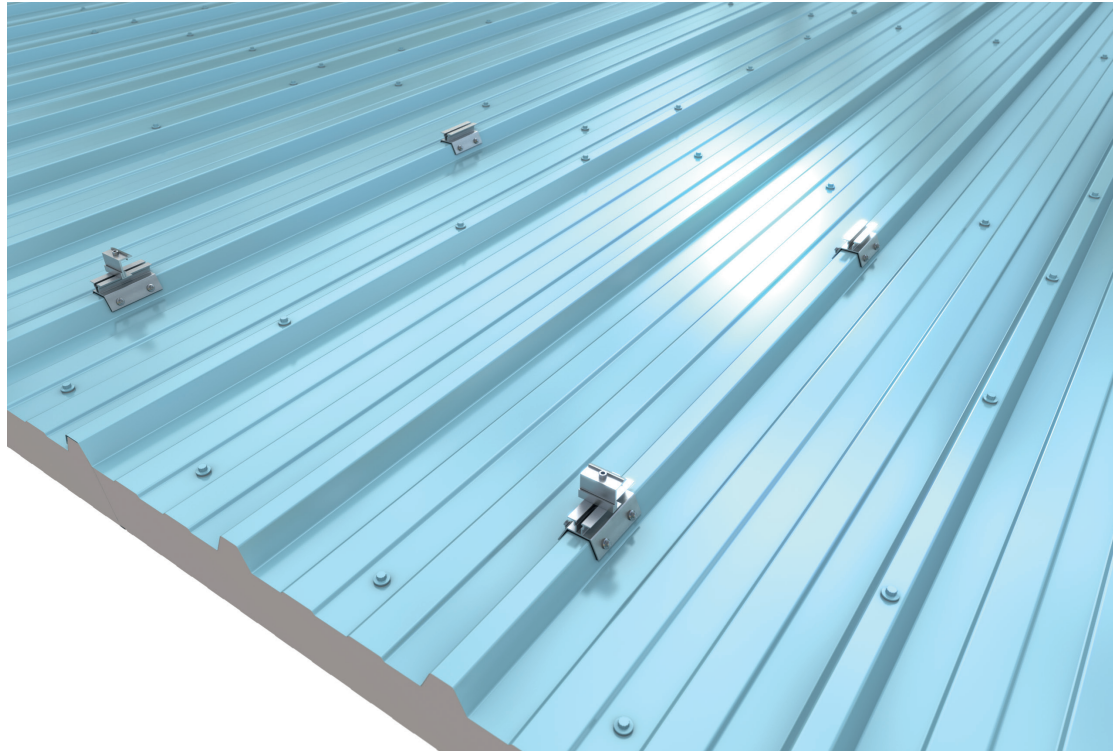

Kingspan PowerRail RW Rooftop Solar PV Mounting System

Installation Guide

Installation Instructions

14b

Modules should be installed so that they are centred on the module clamps. During installation check the distance between the module clamp and the end of the module is equal on both sides. This ensures an even distribution of load to both clamps.

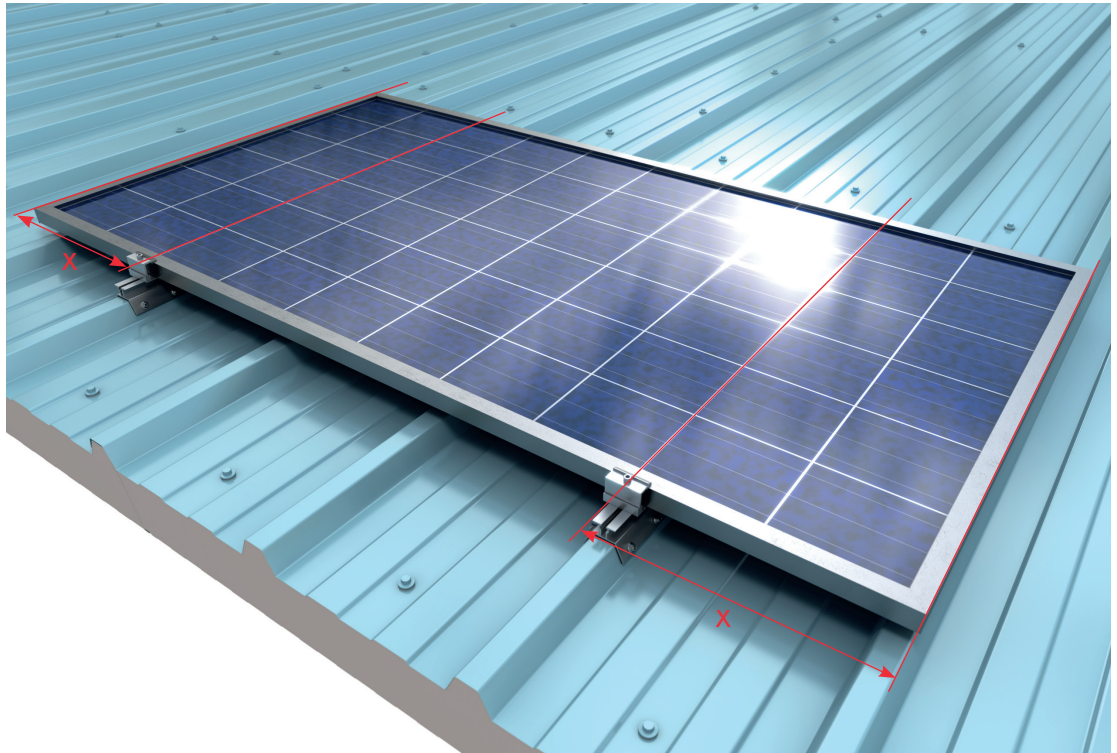

Kingspan PowerRail RW Rooftop Solar PV Mounting System

Installation Guide

Installation Instructions

15

Once the first solar PV module has been aligned and is square to the rails the end clamps can be tightened. End clamps should be tightened to a torque of 10Nm and must not be over tightened.

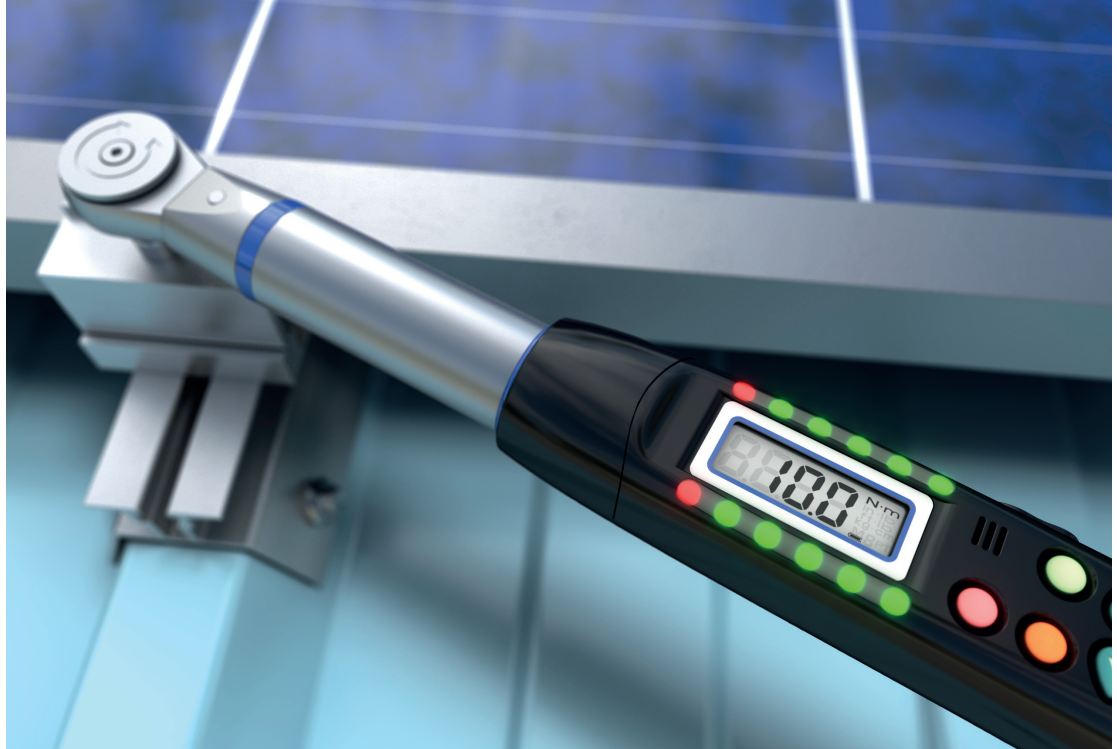

Kingspan PowerRail RW Rooftop Solar PV Mounting System

Installation Guide

Installation Instructions

16

On the opposite side of the solar PV module position the corresponding module mid clamps. Do not tighten the mid clamp at this time.

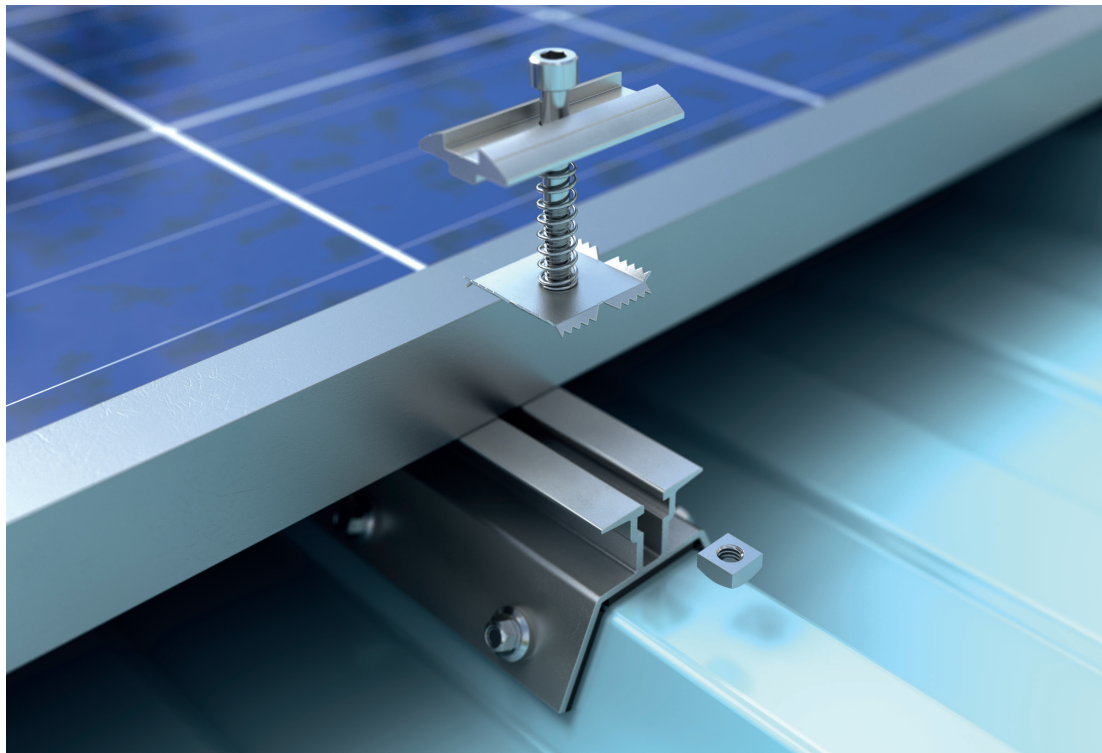

Kingspan PowerRail RW Rooftop Solar PV Mounting System

Installation Guide

Installation Instructions

17

Insert and align the second solar PV module prior to final tightening of the mid clamps. Once the second solar PV module has been aligned and is square to the first, the mid clamps can be tightened. Mid clamps should be tightened to 10Nm and must not be over tightened.

When installed correctly the gap between the two modules should be 10mm.

18

Solar PV modules are fragile elements. Installers should never walk, lean, rest tools or put any undue pressure on the face of the solar PV module during installation. Any of these may result in microscopic stress fractures within the cells which may result in the development of hot spots and premature module degradation.

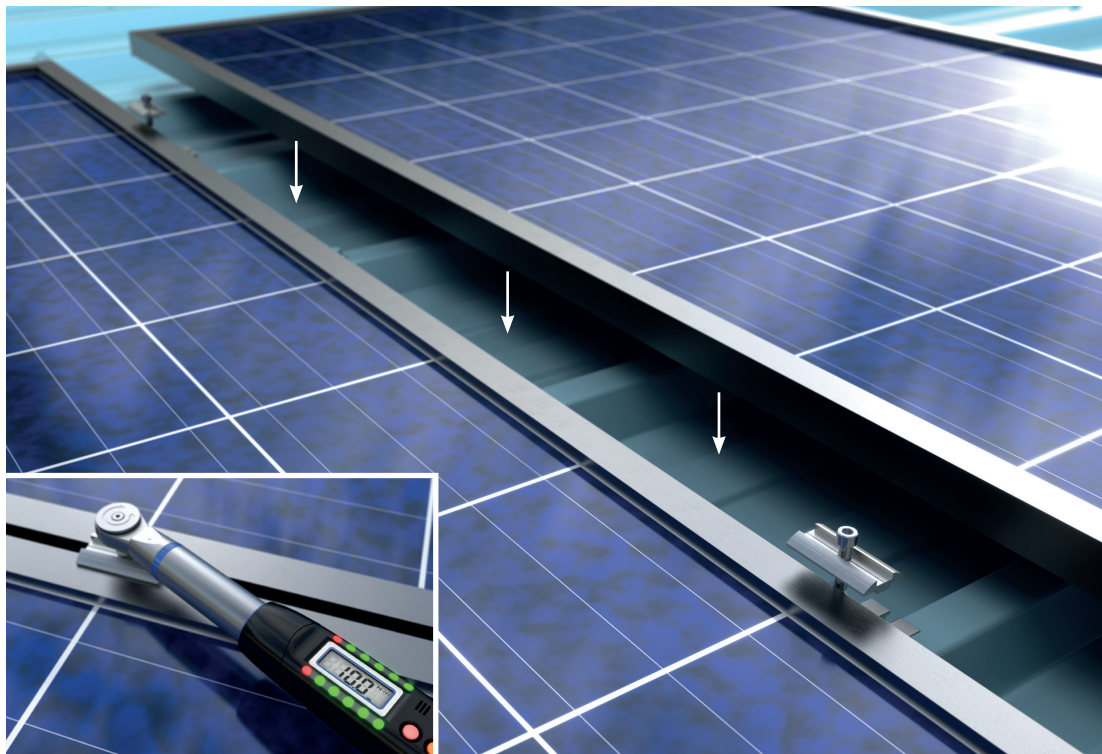

Kingspan PowerRail RW Rooftop Solar PV Mounting System Installation Guide

Installation Instructions

19

Once the final solar PV module has been aligned the end clamps can be installed and tightened. End clamps should be tightened to 10Nm and must not be over tightened.

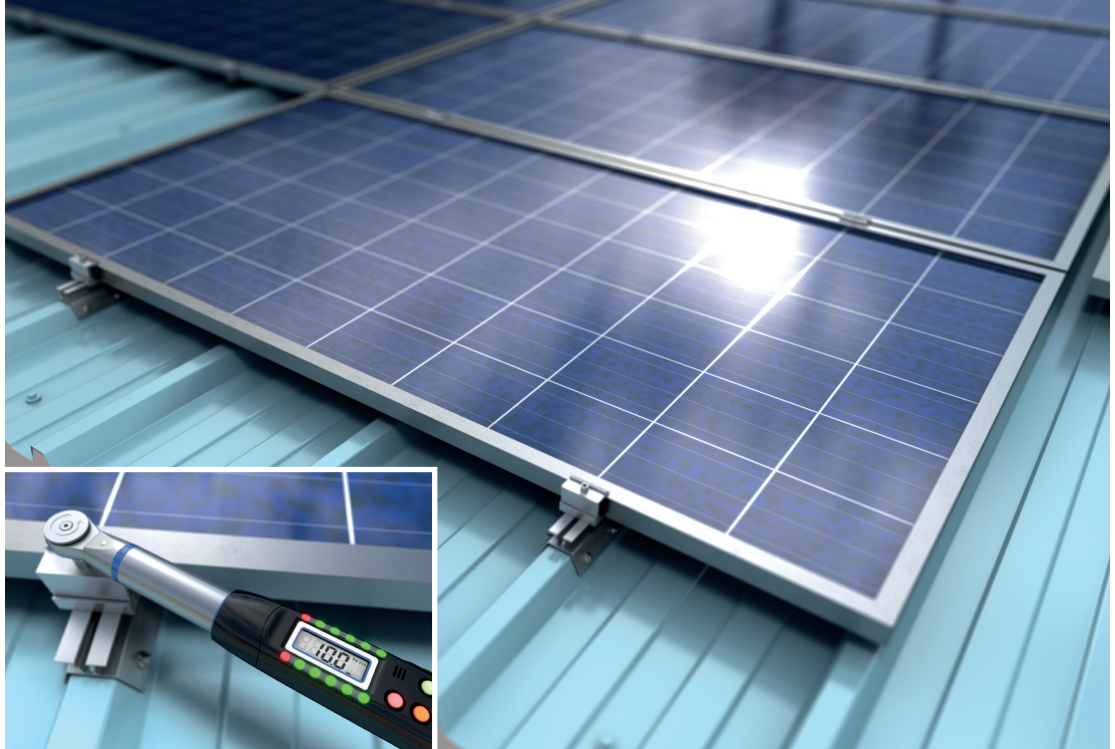

Kingspan PowerRail RW Rooftop Solar PV Mounting System

Installation Guide

Installation Instructions

20

Kingspan PowerRail can also be used for securing cable containment to the QuadCore® KS1000RW Roof Panel.

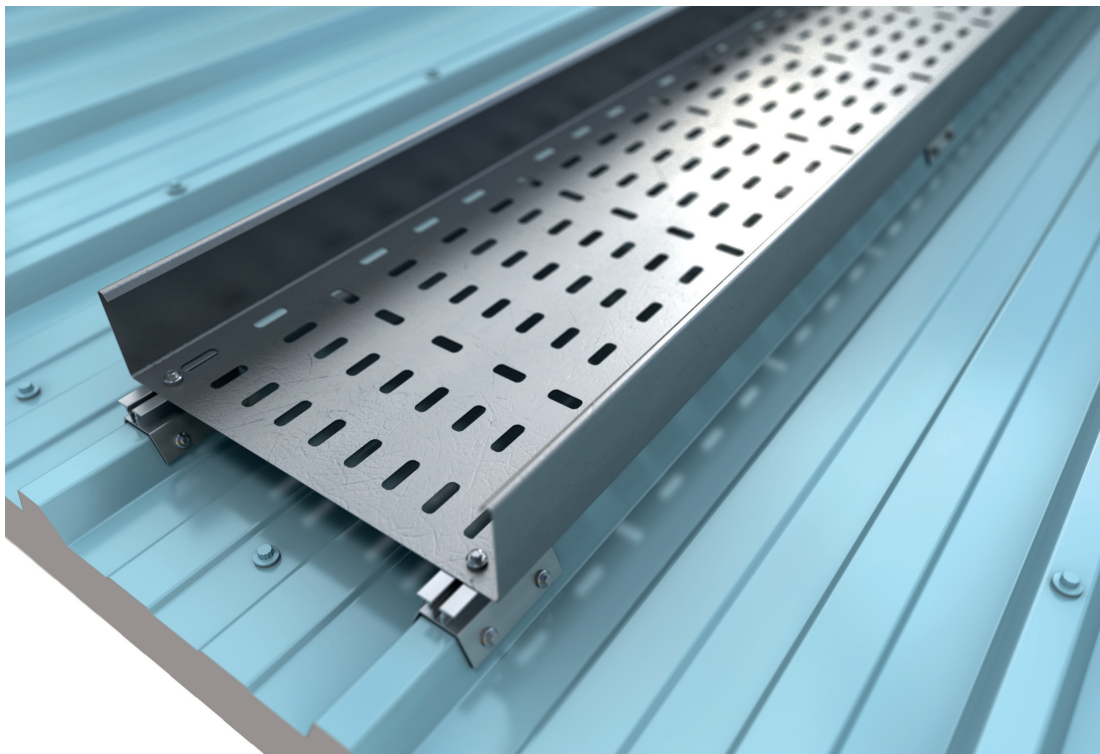

Kingspan PoweRail RW Rooftop Solar PV Mounting System

Installation Guide

Maintenance

It is recommended that, once installed, the solar PV array and Kingspan PoweRail RW mounting system be inspected regularly to ensure maintained correct operation. Even when installed in line with manufacturers guidance, PV mounting systems may require adjustment to correct adverse effects of severe weather conditions (storms, heavy ice and/or snow).

Any regular inspection should be carried out by suitably trained and qualified personnel employing appropriate health and safety processes and procedures. Inspections should include a thorough visual inspection of the PV array and mechanical inspection of the Kingspan PoweRail RW PV mounting system.

- Installation in line with installation instructions – The installation should be visually inspected to ensure the Kingspan PoweRail RW system has been installed in line with the installation instructions.
- Misaligned PV module – If a module is obviously misaligned from other modules in the array this may indicate that the underlying mounting system has become loose. Misaligned modules should be re-adjusted and all associated clamps and rails assessed. Where required, any loose or damaged components should be tightened or replaced.
- Loose or misaligned module clamps – Module clamps should be secured tightly to the top of the module frame while also remaining aligned with the side of the module frame. If a module clamp appears to have a loose connection to the module or, a module clamp is not aligned with the module frame, the module clamp, or clamp bolt, may have become loose. Where required, any loose or damaged components should be tightened or replaced.
- Loose or misaligned rails – Rails should be assessed to ensure they are secure, and properly fitted to the roof using the correct number of fixings. Rails should not show any sign of movement. Where required, any loose or misaligned rails should be tightened or replaced.
- Fixings – fixings should be assessed to ensure they are secure with sealing washers showing the correct compression in line with the Kingspan PoweRail RW installation instructions.

- Damage to module clamps or rails – Where any component(s) of the Kingspan PoweRail RW PV mounting system has suffered obvious damage, these are to be considered compromised and must be replaced. Damage may be caused by falling debris, foot traffic across the array, movement of materials and/or equipment over or around the array.
- Alteration or modification made to the mounting system –The Kingspan PoweRail RW PV mounting system is designed to be used as supplied and as outlined in the installation instructions. If any of the system components have been modified then these are to be considered compromised and must be replaced to bring the system back in line with the installation instructions.

Alteration or modification includes but is not limited to:
 - a) Cutting, drilling or otherwise modifying the dimensions of the rail.
 - b) Cutting, drilling or otherwise modifying the dimensions of the module clamps.
 - c) Using third-party fixings to secure the rail.
 - d) Using third party module clamps.
 - e) Any other alteration or modification of the Kingspan PoweRail RW PV mounting system such that it is no longer capable of being used as intended and outlined in the installation instructions.

Any items noted during an inspection should be documented in full and a suitable record should be maintained for the PV installation. Where any of these items can be corrected, these corrections should be made to bring the installation back in line with the conditions outlined in the installation instructions for the Kingspan PoweRail RW PV mounting system.

Kingspan PoweRail RW Rooftop Solar PV Mounting System

Installation Guide

QuadCore® KS1000RW Roof Panel Coating Warranty

When a PV array is installed above QuadCore® KS1000RW Roof Panels the roof sheeting is no longer exposed to normal weathering conditions and regular wash down by rainfall. These conditions can result in an accumulation of dirt/debris or airborne salts underneath the PV array. To address this additional maintenance and inspection will be required.

In order to maintain QuadCore® KS1000RW Roof Panel coating warranty it is recommended that:

- The area of roof under the PV array cannot be considered maintenance and inspection free.
- The area must be regularly inspected, documented and cleaned, while retaining accurate records for future reference.
- The frequency of inspection, cleaning and maintenance should be commensurate with local environmental conditions.

Wind Uplift Resistance

Kingspan PoweRail RW has been tested to EN 14437:2004 - Determination of the uplift resistance of installed clay or concrete tiles for roofing - Roof system test method - in line with MCS012 requirements.

The system assembly as tested consisted of 2 No. modules (1,722mm X 1,134mm) secured to QuadCore® KS1000RW Roof Panel.

This assembly achieved a characteristic value for wind uplift resistance of 12,041N or 3,083Pa. The test report for above is available upon request from the Kingspan Solar Team.

Assuming a material safety factor (γ_m) of 1.5 the design wind uplift resistance for this assembly equates to 8,027N or 2,055Pa.

For further information on wind uplift resistance of PoweRail RW or project specific wind load calculations, please contact the Kingspan Solar Team.

Installation guides are available for most of Kingspan insulated roof and wall panels.
Please call Kingspan Tech-eXchange team on the numbers below.
For the most up to date version of this Installation guide please scan the relevant QR codes below.

United Kingdom

Kingspan Limited

Greenfield Business Park No. 2,
Greenfield Holywell, Flintshire,
North Wales CH8 7GJ

T: +44 (0)1352 716101
or Freephone: 0800 587 0090
info@kingspanpanels.com
www.kingspanpanels.co.uk



Ireland

Kingspan Limited

Carrickmacross Road, Kingscourt
Co. Cavan, A82 E897

T: +353 (0) 42 9698529
info.ire@kingspanpanels.com
www.kingspanpanels.ie



For the product offering in other markets please contact your local sales representative or visit
www.kingspanpanels.com

Care has been taken to ensure that the contents of this publication are accurate, but Kingspan Insulated Panels and its subsidiary companies do not accept responsibility for errors or for information that is found to be misleading. Suggestions for, or description of, the end use or application of products or methods of working are for information only and Kingspan Insulated Panels and its subsidiaries accept no liability in respect thereof.

Second Issue : August 2024

